

PATENT SPECIFICATION

(11) 1 489 572

1 489 572

- (21) Application No. 45304/74
- (22) Filed 18 July 1973
- (62) Divided out of No. 1 489 571
- (23) Complete Specification filed 18 Oct. 1974
- (44) Complete Specification published 19 Oct 1977
- (51) INT CL<sup>2</sup> G06F 15/20
- (52) Index at acceptance  
G4A 10A 13B 13M 17P 4X 5A 6G 9C 9X U
- (72) Inventors JOHN HUGH COLIN LEACH, ARTHUR ALBERT OWEN, ALAN ARTHUR RUSHTON, ANTHONY ARTHUR PRICE, JAMES ANTHONY MONAHAN, and ROGER MARTIN HODGSON



(54) COMMUNICATION SYSTEM

(71) We, AUTOMATED REAL-TIME INVESTMENTS EXCHANGE LIMITED, a British Company of Roman Wall House, 1/2 Crutched Friars, London, EC3N 1AN do hereby declare the invention, for which we pray that a patent may be granted to us and the method by which it is to be performed, to be particularly described in and by the following statement:—

This invention relates to apparatus in which it is possible to effect trading in fungible properties, such as securities, amongst a plurality of subscribers to the system.

British Patent No. 1,304,421 describes such a communication system. As described in the aforesaid patent, the system includes a central data processing apparatus and a plurality of subscriber stations connected thereto. The system is described with reference to the buying and selling of securities. The central processing apparatus maintains a list of securities for sale which list includes both the quantity of securities for sale and the prices asked, and a list of offers to buy securities, which list includes both the prices offered and the number of securities required. The system is set up so that when a new offer to sell securities comes in from a subscriber station the new offer is compared with the offers to buy in the buy offer list and a transaction is automatically effected if an appropriate matching of the new sell offer with a buy offer on the list takes place. Any untransacted portion of the new sell offer is added to the sell offer list. Similarly, when a new offer to buy comes in from a subscriber station it is compared with the sell offers and transacted if matching takes place, any untransacted portion of the new offer being inserted on the buy offer list. When a transaction takes place, the relevant list is up-dated.

Also, the apparatus of British Patent No. 1 304 421 includes facilities to enable any subscriber to obtain at his terminal complete read-out of the buy or sell offer list relevant to any security which he specifies. Thus, before entering any binding offer, which will be automatically transacted with any compatible entries on the relevant list, the subscriber can see precisely what is available.

The present invention provides apparatus operable to effect transactions in property, comprising a plurality of terminals, each including means for the input and output of data into and from the apparatus;

- a data processor adapted to receive data from and transmit data to said terminals;
- data storage means for recording data; and
- program means having instructions to cause said processor:
  - (a) to record in said storage means expressions of interest, received from the terminals, in buying and selling said property, said expressions of interest specifying a quantity of said property and a price therefor;
  - (b) to search said storage means, on command of a terminal transmitting to said processor data representing a requirement to deal in said property, for expressions of interest originated by other said terminals compatible with the requirement data, and to transmit only located compatible expressions of interest to the terminal commanding the search; and
  - (c) to record a transaction in said property in predetermined circumstances.

Thus, the apparatus according to the present invention has a search facility,

BEST AVAILABLE COPY

not provided in the apparatus of the above British Patent, in which search facility there is transmitted to the terminal commanding the search only expressions of interest compatible with requirement data specified when commanding the search. Such data preferably specifies requirements as to quantity of the property to be dealt in, either exactly or a range of quantities.

The invention is applicable to systems as described in the above British Patent, in which the expressions of interest recorded in the system are in fact binding bids to buy or offers to sell property. However, it will be readily understood that where the present invention is provided, the use of the search facility does not involve the recording in the system of a binding bid or offer. The invention is alternatively applicable to a system as described in our copending Application No. 34229/73, Serial No. 1 489 571, from which the present application is divided, in which the expressions of interest recorded in the system are non-binding and are used as a basis for the direct transmission between terminals of binding bids or offers on the basis of which transactions may be recorded.

Since British Patent Specification No. 1 304 421 fully describes a system in which the expressions of interest recorded in the system are binding bids and offers, no further description of such system will be given in relation to the present invention, which will be illustrated in its preferred embodiment in a system in which non-binding expressions of interest are recorded.

The invention is described further by way of example with reference to the accompanying drawings, in which:

Figure 1 is a block diagram of a communication apparatus embodying the invention, for enabling subscribers to buy and sell securities from each other anonymously;

Figure 2 is a block diagram showing in more detail the hardware that each subscriber is provided with;

Figure 3 illustrates a keyboard included in the apparatus of Figure 2;

Figure 4, which is made up of Figures 4.1 to 4.8, is a flow chart illustrating how the system operates to provide a subscriber with predetermined information regarding a particular security handled by the system, this facility being referred to as "QUOTE" herein;

Figure 5, made up of Figures 5.1 to 5.5, is a flow chart illustrating the operations of the system which take place when one subscriber searches for another with compatible requirements, this being referred to herein as the "SEARCH" facility;

Figure 6, made up of Figures 6.1 and 6.2, is a flow chart illustrating the operations which take place in the system when a subscriber wishes to make an entry in the register representing an expression of interest to buy or sell specified securities in specified price and quantity, this being referred to herein as "ENTER BOOK";

Figure 7, made up of Figures 7.1 and 7.2, is a flow chart illustrating the operations which take place in the system when a subscriber wishes to alter an entry of his own which is already in the system, this being referred to herein as "ALTER BOOK";

Figure 8, made up of Figures 8.1 and 8.2 is a flow chart illustrating the operations which take place in the system when one subscriber wishes to contact another with a view to negotiating, this facility being referred to herein as "CONTACT";

Figure 9 is a flow chart illustrating the operations which take place in the system when one subscriber makes an offer or bid to another subscriber with whom he has made contact using the contact facility, the facility of Figure 9 being referred to herein as "OFFER/BID";

Figure 10 is a flow chart illustrating the operations which take place in the system when one subscriber wishes to send a message to another with whom he has made contact using the facility of Figure 8, the facility of Figure 10 being referred to herein as "MESSAGE"; and

Figure 11, made up of Figures 11.1 to 11.3, is a flow chart illustrating the operations which take place in the system when a bargain is struck between two subscribers who have negotiated using the "OFFER/BID" facility of Figure 10, the facility of Figure 11 being referred to herein as "ACCEPTANCE".

#### Hardware And Data Stored

With reference to Figure 1, the apparatus according to the preferred embodiment of the invention comprises a central computer 100 which includes a processor

unit 102, a core memory 104 and four magnetic disc storage units 106, 108, 110 and 114. The apparatus further comprises a plurality of subscriber stations 116, 118, 120 and 122. Although only four subscriber stations are illustrated in Figure 1, there will in practice be many more such stations. In addition, the system includes a monitor station 124 for the purpose of monitoring the various activities which take place on the system.

The basic object of the system is to enable the various subscribers to negotiate with each other for the purchase and sale of securities. However, during such negotiations each subscriber is to be anonymous to the others so that no subscriber knows who he is negotiating with. Negotiations may be initiated by any subscriber who becomes aware of another who has compatible requirements. Subscribers may enter into the system details of their interest to buy or sell. The details entered include the identity of the stock and the quantity and price at which the subscriber wishes to deal. Such details may be stored in the system and when so stored will be referred to as "entries". Any subscriber may instruct the system to locate the entries of other subscribers, if any, compatible with his own requirements. The system, however, will not, in an embodiment, permit any subscriber to discover all available entries, which may be either sell entries (expressions of interest to sell items) or buy entries, (expressions of interest to buy stock), on the stock which he is interested in, i.e. he can only discover compatible entries, unless it so happens that all entries at a particular time are compatible. The computer 100, therefore, has stored within it certain data concerning the subscribers to the system, data concerning the stocks which the system is handling, data concerning entries which given subscribers have put into the system, data concerning negotiations currently taking place, and programs for controlling the system to carry out various required functions including those mentioned above.

To enable the subscribers to enter data into and receive data from the system, each is provided with the hardware illustrated in Figure 2. This comprises a keyboard 126 for entering data, a video display unit 128 and a printer 130 for outputting data, and a local computer unit 132, for controlling the input and output of data by the units 126, 128 and 130 and the transmission and reception of data to and from respectively the central computer 100. The local computer 132 comprises a processor 134, a read-only memory 136 and a random access memory 138.

The apparatus of Figure 2 will be located, in operation of the system, at the premises of the different subscribers. The subscriber apparatus may be connected to the central computer 100 by any suitable means, for example, Post Office land lines.

Magnetic storage disc unit 106 of the central computer 100 contains the data which the system requires on each stock which the system can handle. This information may be regarded as being divided into a plurality of separate "books", one book for each stock. Each book, in turn, may be regarded as in two sections, one section containing the data which is normally fixed in relation to the stock in question, and the other section containing data which varies as different subscribers put in or remove buy or sell entries in connection with the stock or alter the entries which they have already made, or which varies as entries in the book are traded and thus require cancellation or up-dating.

The fixed data stored in each book is as follows:

(a) *Stock Code*

This is simply a code by which the stock is identified in the system. It is preferably such that the subscribers themselves can readily identify which stock it refers to. For example, a suitable code for Imperial Chemical Industries would be ICI, or for British American Tobacco Company would be BATS.

(b) *Stock Name*

If necessary the name of the stock may be abbreviated to enable it to be located in allowable storage space. For example, the British American Tobacco Company might be abbreviated to BRIT-AMERICAN TBAC.

(c) *Stock Status*

In order to enable subscribers to train, various fictional stocks will be included in the system so that training can be achieved without subscribers incurring any liability. Furthermore, in the case of actual stocks, as opposed to training stocks, it may arise from time to time that trading in a particular stock is prohibited and thus the system has provision for placing a "hold" on any stock to prevent trading

therein. Thus, the stock status data includes an indication of whether the stock is a fictional stock for training and also, in the case of actual stocks, whether or not the stock is subject to a hold.

(d) *Price Control Data*

This includes:

- i. Currency in which the stock is quoted, for example pounds sterling (£) or pence or U.S. dollars (\$).
- ii. An indication as to whether the stock is stored on a per share basis (in the case of equities for example) or on a per 100 nominal basis (for example in the case of fixed interest loans).
- iii. An indication as to which price formats are allowable for the stock in question. For example, price may be quoted in the format of pounds and pence e.g. £2.25 or as pounds and fractions of pounds e.g. £2¼, or in terms of pence and fractions of pence, e.g. 324½.

(e) *Price Qualifiers*

Stocks may be bought and sold cum or ex (i.e. inclusive of or exclusive of dividend, cum or ex rights, and cum or ex capitalisation (sometimes known as bonus). Some stock may be dealt with without such qualifiers. Accordingly, the stock data includes an indication as to whether each stock has one or more of these qualifiers associated with it and, if there is a qualifier associated with the stock, three dates are also stored for the or each qualifier as follows:

- i. The date of the start of the period in which the stock is still cum but may be dealt ex; this will be referred to as Date 1.
- ii. The date of the start of the period in which the stock is ex and must be dealt ex; this will be referred to as Date 2.
- iii. The date of the end of the period in which the stock is ex and must be dealt ex; this will be referred to as Date 3.

Accordingly, before Date 1, the stock will automatically be dealt cum dividend, rights or capitalisation according to which qualifier the date relates to; between Dates 1 and 2 the stock may be dealt in either cum or ex; between Dates 2 and 3 the stock will automatically be dealt in ex; and after Date 3 the stock will be dealt automatically be dealt in only cum.

iv. In the case of stock which can be dealt in cum or ex dividend, data may also be stored to enable calculation of the accrued interest to be paid.

(f) *Commission/Settlement Codes*

This data comprises the following:

- i. Minimum consideration i.e. the minimum monetary size of any deal in the particular stock.
- ii. The commission payable to the managers of the system according to the invention on deals in the particular stock. This will normally be a percentage.
- iii. Taxes payable, for example Value Added Tax or Inland Revenue Stamp Duties.

iv. If two subscribers consummate a number of deals in the same stock within a given period, the commission payable on the total will be computed as if it were a single deal. This computation will be such that the commission which the subscribers will therefore have to pay on such a series of deals may be less than if they were treated as separate deals. The period allowed for each stock may be different. Accordingly the relevant period for each stock, which will be referred to as the continuation period, is stored.

v. The next date, herein referred to as the settlement date, on which the liabilities incurred by the subscribers in making deals in the particular stock must be settled.

As has been indicated, subscribers may enter into the book on a particular stock expressions of interest in buying or selling a given quantity of that stock at a given price. The contents of this section of the book will, therefore, be constantly changing as subscribers enter new expressions of interest, alter or withdraw existing expressions of interest, or strike bargains. In addition, a number of recently traded entries are maintained, to give an indication of activity taking place in connection with the particular stock. In a typical example, there will be space in this part of the book to store twenty entries representing expressions of interest and four entries which have been traded. In connection with each entry, the following data is stored:

- (a) An entry number which identifies each particular entry. This number is

generated automatically by the system when a new entry is put into the book. It is used by subscribers in referring to that entry.

(b) In the case of expressions of interest, whether the entry is an interest to buy or an interest to sell, and the identity of the subscriber who entered it. In the case of traded entries the identity of both buyer and seller is stored.

(c) The quantity of shares involved.

(d) The price together with price qualifiers where relevant.

(e) The system may be provided with means whereby a subscriber putting an entry into the book may designate that certain other classes of subscriber only should be allowed access to his entry. For example a given subscriber may on a particular occasion wish to exclude merchant banks from particular entries. Accordingly, data as to which classes of subscriber are to be allowed access to excluded is also stored.

(f) Whether the entry was broadcast when entered or last altered. Non-broadcast entries will be referred to as discreet entries.

(g) Subscribers may indicate for each entry that it will expire within a given time, say ten minutes from the time of entry, may indicate that it is to remain good till cancelled, or may provide no indication, in which case the system will automatically cancel the entry at the end of the working day on which it was entered. For live entries, therefore the system stores the time of expiry or an indication that it is good till cancelled; for traded entries, the system stores the time at which the trade took place.

(h) The date on which the entry was loaded into the system, both in the case of live entries and traded entries.

Magnetic disc storage unit 108 contains data on each subscriber. This data is as follows:

(a) The name of the subscriber.

(b) A number and four character mnemonic identifying the subscriber. It is important to note that during negotiations no subscriber has any indication of the identity of the subscriber with whom he is negotiating. This data is, therefore not revealed during negotiations; it is used simply for identification of the subscribers at the monitor station. Thus, the monitor station monitors all activities on the system and the identities of the subscribers performing such activities.

(c) A passcode. This is a code to be used by the subscriber when opening up his terminal for operation, herein to be referred to as "signing on". In addition, there is a set of initials representative of the authorised operator at the subscriber station, to be used in conjunction with the passcode. If desired several sets of passcodes and initials may be stored to enable several different operators at each subscriber station to use the equipment. The passcode and initials are essentially for security purposes to ensure that unauthorised persons cannot incur liabilities on behalf of a subscriber.

(d) Company code. Some subscribers may require more than one terminal. The company code is used to prevent such dealing between the different terminals of one subscriber.

(e) Group code. This is to define which group of subscribers the particular subscriber belongs to, for example, merchant banks, insurance companies etc.

(f) Subscriber status. This data will vary according to the status of the subscriber at any particular time, his status being defined by the following:

i. Is the subscriber signed on or not?

ii. Is the subscriber signed on for training only?

iii. Does the subscriber wish to receive hard copy of broadcast messages?

The system is set up so that certain information is always provided in hard copy form as well as on his video display unit, but the provision of hard copy of broadcast messages is optional.

iv. Is the subscriber on hold? From time to time it may be desired to prevent certain subscribers from operating the system, for example due to misbehaviour or failing to meet their commitments. In such cases the subscriber will be put on "hold".

The above gives the most important information stored for each stock and each subscriber. Further information may be stored as desired.

Magnetic disc storage unit 108 is in addition used to store information on each negotiation taking place. As has been explained, a subscriber may cause the system to search the book of a particular stock for entries compatible with the subscriber's requirements. As a result of the search, the subscriber may be informed, on his video display unit, of a number of compatible entries. If he wishes to enter

negotiations with the person who has inserted one of those entries, it is necessary for him to make contact with that person, through the system, preserving anonymity as previously mentioned. To make this possible, the system will allot a contact or conversation number with each entry revealed by his search. The use of the contact or conversation number will then enable the subscriber to make contact with the person who has inserted the entry of interest but without either knowing the identity of the other. The data stored on the unit 108 in connection with each negotiation or conversation is as follows:

(a) The conversation number. These are allotted essentially arbitrarily by the system. In practice they are preferably allotted in sequence so that each new potential conversation is given a number having a value greater by unity than the number of the previous conversation.

(b) The entry reference. This is the stock code, stock name and entry number of the entry being negotiated in this conversation.

(c) The identity of the subscribers taking part in the conversation. This is preferably by way of the subscriber numbers.

(d) After a conversation starts, each message in the conversation is assigned a number by the system, and this number will be referred to as the "reply number". Thus, the subscriber initiating a negotiation will, using the contact number, send a first message to the subscriber who has inserted the entry of interest. This message will be identified by the reply number 1. The person who inserted the entry will then, if he wishes, reply and his reply will be identified by the reference number "2". The next reply from the original subscriber will therefore be numbered 3 and this procedure will continue throughout the negotiation. Accordingly, the value of the next reply number is stored.

(e) The latest reply made by each subscriber is stored. The data stored for each subscriber's reply comprises:

i. The quantity of stock quoted in the reply.

ii. The price quoted in the reply, including qualified if any.

iii. Whether the reply is an offer to sell (offer) or a bid to buy (bid).

iv. The expiry time of the bid or offer made in the reply.

Additional, miscellaneous data, is also stored in the system. During the working day while the system is operating, this miscellaneous data will be stored for ready availability in the core memory 104, but when the system is not operating, for example overnight and at week ends, this data will be transferred to disc storage unit 108. This miscellaneous data is as follows:

(a) Date of present working day.

(b) Next settlement date. There are specified dates for settlement on certain stocks. Thus the settlement date data incorporated in the book on each stock will indicate whether the transactions in that stock have to be settled on the next settlement date or whether settlement is on the next working day following the transaction. These two alternatives are the only permitted alternatives in the system.

(c) The next entry number. It will be recalled that this is a number identifying each entry in the books on the different stocks, each entry having a unique number.

(d) Next conversation number. It will be recalled that each conversation or contact is assigned a number. An assigned number will remain good for the whole of the remainder of the working day so that a given pair of subscribers may continue to communicate with each other using the same contact number throughout the whole of the day in which that contact number was assigned to them for the purpose of a specific negotiation. Nevertheless, as previously emphasized, such contact remains anonymous.

(e) Next bargain number. Each time a bargain is struck, this is assigned a number.

(f) Each action which takes place on the system by subscribers is assigned a number for identification purposes. This is called a "monitor slip number" herein and thus this miscellaneous information includes the next monitor slip number to be assigned. Such numbers are not indicated to subscribers.

The magnetic disc storage unit 110 is used to log the operations which have taken place on the system in the order in which they have arisen. Thus each operation is stored on the disc unit 110 in numerical order of the monitor slip numbers. Thus, the monitor slip numbers are utilised in the location of information in the unit 110 and are also displayed at the monitor station 124.

The magnetic disc storage unit 114 is used for the storage of the programs necessary for causing the system to carry out the required functions and operations, a number of which have already been referred to in general terms. In

addition, this unit 114 has proformas stored therein, which, upon command of a subscriber, are displayed upon his video display unit 128 to advise him of the format in which information is to be entered into the system.

The screen of the video display unit 128 is divided into three areas, an upper area 140, a central area 142 and a lower area 144. These areas are separated from one another by broken line 146 which is between the upper and central areas and 148 which is between the central and lower areas. The lines 146 and 148 are created as displays on the video display unit 128, rather than being marked on the screen. However, the position of line 146 is fixed. The position of line 148, however, may be varied in the vertical direction, thus varying the relative sizes of areas 142 and 144. The movement of the line 148 in the downwards direction, thereby to increase the size of the area 142 takes place automatically as additional information to be displayed in the area 142 is applied to the unit 128, that is to say the information to be displayed in area 142 takes precedence over that to be displayed in area 144. Movement of the line 148 in the upwards direction, however, can be achieved manually so that the operator of the subscriber station may, if he wishes, obliterate some of the information in area 142 in favour of providing an increased size for the area 144 thereby permitting more information to be displayed in that area.

As will be apparent from the above, different information is to be displayed in the different areas of the screen. The upper area 140 is for the display of the above-mentioned proformas, when called up by the operator, and for the display of information keyed into the terminal by the operator, but before such information is transmitted to the central computer 100. Also, if there are errors in the data keyed in, messages from the central computer advising of the errors will be displayed in area 140.

The central area 142 is for the display of messages from the computer 100 confirming that the computer 100 has acted upon instructions keyed in by the subscriber, and for the display of bids or offers received, messages received from other stations and confirmations of bargains, all directed exclusively to the particular subscriber station in question. This area is also used for display of messages from monitor station which messages may be directed to selected or all subscribers. The lower area 144 is for the display of information which is received from the central computer 100 but is broadcast generally i.e. is sent to all subscriber stations in the system and also for notification that any entry of the particular subscriber has been located by another.

The keyboard 126 includes a section 150 containing individual keys for each of the alpha-numeric characters and in addition containing keys 152 and 154 for keying in the sign for pounds sterling (£) and for dollars (\$) respectively, keys 156 and 158 for keying in respectively double zeros "00" and treble zeros "000", indicative of hundreds and thousands respectively when preceded by other numeric characters, a key 160 for the oblique "/", a key 162 for the decimal point, keys 164 and 166 for plus "+" and minus "-" signs respectively, a key 168 for an asterisk "\*", a key 170 for the symbol shown representing the word "at", a key 172 for the percentage symbol "%" and three keys 174 for the respective punctuation marks shown in the drawing. In addition, there is a key 176, which will be referred to as a "separator" key, whose function is to separate input information when using certain specified proforma, as will be described subsequently in more detail.

The conventional space bar is indicated by reference number 178.

A further group of keys 180 labelled respectively "BUY", "SELL", "YES", "NO", "1/4", "1/2", "3/4" is provided for inputting the data indicated on the key. This group of keys 180 is provided, as are the keys 170, 156 and 158, because the data input thereby is commonly used and thus these keys save the operators of the system the task of putting such common data in character by character.

A group of keys 182 is provided for calling up to the screen the proformas appropriate to different operations to be performed. In this group, the key 184 is used for calling up the proforma for the QUOTE facility in which the subscriber wishes to obtain information on the trading that has taken place in a given stock; the key 186 for the SEARCH facility in which the subscriber wishes to locate expression of interest to buy or sell a given stock compatible with his own requirements; the keys 188 and 190 for respectively entering and altering offers in the book on a given stock; the key 192 to obtain a contact number for use in negotiating about a particular entry that has come to the subscribers notice; a key 194 for sending an offer or bid to another subscriber; a key 196 for accepting an offer or bid; a key 198 for sending messages to other subscribers using previously obtained contact numbers or to the monitor 124; a key 200 to enable the subscriber to obtain

extra "pages" of information (for example if the use of the SEARCH facility results in more entries being located than can be output at once to the subscriber's terms, depression of key 200 after the initially displayed information has been studied enabling the initial information to be replaced with the further information, this being called the page facility since it is rather analogous to turning the pages of a book); and a key 202 for calling up a general proforma for certain other activities.

The video display unit produces, in the upper part 140 of the screen, a cursor 206 which is in the form of a white rectangle and which indicates the position in the area 140 in which a character entered by way of the keyboard will be displayed. Thus as messages are entered, the cursor will move. A key 208 is provided for returning the cursor to its start position i.e. its extreme top left hand position, and keys 210 and 212 are provided for displacing the cursor to the left and the right respectively on a given line, one character space at a time for each depression of the relevant key. In this way, by back spacing the cursor using the key 210, it can be positioned coincident with a previously entered character or space and that character changed or the space filled; and thereafter using the key 212 the cursor can be moved to the right to the appropriate position to continue with the entry of data. Thus, corrections may be easily effected.

A key 214 is for tabulation, and causes the cursor 206 to move from its current position to the position at the beginning of the next information field. A key 216 causes messages which have been entered into the terminal by way of the keyboard to be transmitted to the central computer 100. During transmission, the keyboard is automatically locked, and is then unlocked, after the central computer has received and processed the whole of the message, in response to an unlock signal from the central computer. A key 218, labelled UNLOCK is provided to unlock the keyboard in the event that, due to a fault, it does not become automatically unlocked.

A key 220 is provided for shifting the position of the line 148 upwards. Each depression of the key 220 causes the line 148 to move upwardly a distance equivalent to the spacing between lines of information on the screen.

A group of indicators and controls 222 includes a light 224 which indicates when the power is on; a switch 226 for resetting the terminal, the effect of which is to clear the screen of the display unit (during the resetting operation, the keyboard will be locked briefly); a switch 228 for switching the printer on and off, this switch being illuminated to indicate when the printer is on; a light 230 for indicating that the central computer 100 is operative and that it is permissible for subscribers to carry out the various permitted functions and negotiations; a light 232 which indicates when the keyboard is locked; a light 234 which indicates if there is a fault with the printer; and a light 236 which indicates whenever there is a fault in the transmission system or line between the subscriber station and a central computer 100. Each of the elements in the group 222 is marked with its function.

The read-only memory has the following data stored in it:

(a) Control instructions to determine which area of the screen data addressed to the screen is to be displayed in. Thus, all data addressed to the screen includes address coding as to the area in which it is to be displayed.

(b) Control instructions for the display unit 128 to create the lines 146 and 148. In this embodiment of the invention, the display unit has a capability of displaying a total of twenty five lines of data. The broken line 146 is created in line position 5 by the instructions in the read-only memory. The line 148 is positionable at any position from line position 6 to line position 19. Assuming that the broken line 146 is at line position N then, if N is less than 19, and a new message line has to be displayed in area 2 then the following operations are caused to take place by these instructions:

i. Broken line 148 is rewritten in line position N+1

ii. The new message line is added at line position N.

iii. In the control instructions, the information as to the current position of the broken line 148 is changed from N to N+1.

If a new message line is to be added to area 142 when N=19 then the following operations take place under control of these instructions:

i. All existing information displayed in area 142 is moved up by one line i.e. the information in line 6 is obliterated and that in lines 7 to 18 scrolled up by one line position;

ii. The new line of data is added at line position 18.

(c) It will be appreciated from the above that each time broken line 148 is moved downwards by one line position, the current uppermost line of information



in area 144 of the screen will be obliterated if area 144 is full. In area 144, new information is always added at the bottom, and existing information scrolled upwards to accommodate the new information. Thus, any information cancelled from area 144 as the broken line 148 moves downwards is the oldest information; and similarly it is the oldest information which is cancelled from area 144 due to upward scrolling when new information is added at the bottom at a time when area 144 is full.

Instructions for the creation of the characters to be displayed in response to depression of the various keys on the keyboard, including the creation of the multi-character data to be created by depression of several of the keys, especially those included in group 180.

(d) Instructions for the control of queuing between the terminal and the printer, this being necessary since the printer operates more slowly than the video display unit and thus, there will frequently be queues of data which have already been displayed on the screen but which are still waiting to be printed out by the printer.

(e) Control instructions for the exchange of data with the central computer 100. Such exchange is initiated by the central computer, which is arranged to communicate with the subscriber stations in a continuously repeated sequence.

The random access memory 138 of each subscriber station stores the following information:

(a) The proformas. When a subscriber terminal is reset and when the terminal is signed on to start operations on a particular day, the proformas stored on disc 114 are transmitted by the central computer 100 to the random access memory 138 to be available for immediate call by depression of the keys of the group 182 on the keyboard 126. These proformas are erased from memory 138 when the terminal is reset or switched off. The reason for storing the proformas in the disc 114 rather than permanently storing them in the read-only memory, for example, at the subscriber terminal is so that they can be readily changed if it is desired to modify them for any reason.

(b) Data keyed into the terminal by the keyboard 126 or received by the terminal from the central computer 100. The random access memory is therefore acting as a buffer for such data.

The above completes a description of the main aspects of the hardware employed in the system and of the data which is stored therein, so far as is necessary for an understanding of the invention. A description of the functioning of the system will now be given. Each of the important functions which can be carried out will be described in turn. Description of the proforma used for keying data into the system will be given, as well as details of the way in which the data is displayed on the screen of the visual display unit. In addition, where necessary, flow charts illustrating the operations which take place in the central computer 100 in executing the various functions will be referred to, such flow charts being included in the accompanying drawings as previously mentioned.

#### Sign On

For a subscriber to make use of the system, it is necessary for him to put his terminal into operation by going through the operation of "signing on". In order to sign on, having connected his terminal to the mains power supply, he depresses the key 202 marked "GEN" which is the key for calling up the general command proforma. This key is used for various operations which do not have specifically detailed proforma assigned to them. In response to this, the local computer 132 of his terminal causes the appropriate proforma to be displayed in line 1 of area 140 of the video display unit 128. The following Table 1, is a representation of the proforma displayed and also gives an example of the data which the subscriber thereafter has to key in and of the data which is output by the system in response to the subscriber signing on:

TABLE 1

GEN COMMAND DETAILS  
SON:#PJCS#5164

09.45	SYSTEM	PJCS SIGNED ON				
09.45	LIST	YOUR CURRENT LIVE ENTRIES				P 1/2
	108/ALLD	BUY	30,000+	BROADCAST	@ 87 1/2	GTC
	301/BATS	SELL	80,000+	DISCREET	@ 285	GTC
	250/ECC	BUY	40,000-	BROADCAST	@ 135 XD	GTC
	246/GEC-9	SELL	35,000*	BROADCAST	@ 150	GTC

As can be seen from the above, the general command proforma consists of the words "GEN COMMAND DETAILS", which as indicated appear in line position 1 of area 140. The cursor 206 is automatically positioned, when the proforma appears, in the space at which the data to be keyed in by the subscriber has to begin, for example if there are eighty character spaces in each line on the screen, the starting position for the cursor may be at character space 12. The subscriber then keys in "SON", which is the code for signing on. He then depresses the separator key 176 before keying in his initials which in this example are "PJCS", then he presses the separator key 176 again and he keys in his passcode which in this example is shown as "5164".

In the above Table 1, the broken line which is shown is a representation of the broken line 146 which appears on the screen. It will be recalled that this line 146 is in line position number 5 on the screen. Accordingly, of the four available lines in area 140, only lines 1 and 2 contain information so far. Line 3 is provided for additional message information, as will become apparent when other functions are described. Line position number 4 is for display of messages from the central computer 100 indicating that the subscriber has made an error in the information that he has keyed in on line positions 2 and 3.

It will be noted that in the data keyed in in line 2, the symbol shown on key 176 appears in the spaces between the different words in the message. The only significance of this is that it is necessary to indicate to the system where one word ends and the next begins, and this is achieved by depression of the separator key 176. It will become apparent that this key does not have to be used in connection with the specific function proformas.

Having keyed in the above described information in line 2, the subscriber then depresses the transmit key 216 which causes the data keyed in to be transmitted to the central computer 100. After the central computer 100 has acted upon the data, the action taken is confirmed in the uppermost available line which, in Table 1, of area 142, is the uppermost line of the area, namely line G of the screen. The confirmation begins with an indication of the current time, given as 09.45 followed by the phrase "SYSTEM PJCS SIGNED ON" simply indicating that the subscriber designated by his initials PJCS has signed on to the system.

In response to the data transmitted to it, the central computer automatically obtains the appropriate programme stored on disc 114 to cause the system to obtain from the data stored on disc 108 a list of any current live entries which the subscriber in question has in the system. When these entries are obtained, they are transmitted to the subscriber and displayed in area 142 of his screen. Since the broken line 146 is in line position number 5, the data "09.45 SYSTEM PJCS SIGNED ON" appears in line position number 6 of the screen. Line position number 7 is blank. The data concerning the subscribers current entries begins in line position number 8.

This data also begins with the time at which the list has been produced by the system, namely 09.45 then there is the expression "LIST YOUR CURRENT LIVE

ENTRIES" followed, at the end of the line, by the character P 1/2. This means that the list displayed is incomplete and that further items on the list can be obtained by using the page facility by depressing the page key 200. The first digit of the character P 1/2 signifies the page number of the data being displayed (in this example page 1) and the second digit indicates the total number of pages (in this example, two pages).

The data concerning each individual live entry is all contained in the same line, there being a separate line for each entry. The first entry shown in Table 1 begins with the entry number 108 followed by an oblique followed in turn by the word "ALLD", which is the stock code. Next, the word "BUY" appears indicating that the entry is an expression of interest for the subscriber in question to buy stock for the company identified by the code ALLD. Next the word 30,000+ indicates that the subscriber is interested in buying 30,000 or more shares in the particular company. The word "BROADCAST" indicates that this entry was broadcast to other subscribers at the time when it was inserted in the stock book; when a subscriber puts an entry into one of the books, he has a choice of it being broadcast to other subscribers or being put in "discreetly" i.e. without being broadcast. Next, the symbol for "at" appears followed by the price asked, namely in this case 87½. The final piece of information regarding this particular entry is the initials GTC which means that the entry is good till cancelled. It will be recognised from the foregoing description of the system that only entries which are good till cancelled can be displayed upon initial signing on a given day, since all other entries will have been cancelled by the end of the preceding day's business.

The next entry in the list is identified by number 301, the stock is identified by the code BATS, it is an interest to sell 80,000 or more shares at a price of 285 per share and it was entered into the system discreetly.

The third entry is an interest to buy 40,000 or less, this being the significance of the minus sign, shares in the stock identified by the code ECC, the entry was broadcast, the price offered is 135 per share, and the significance of the qualifier XD following the price is that the price is offered ex dividend.

In the fourth offer shown in the list, which is an interest to sell stock identified by GEC-9, the quantity of 35,000 which is specified is followed by the asterisk symbol "\*". This signifies that the interest is to sell exactly 35,000, no more no less. Other details of the last offer in the list of Table 1 will be apparent from the foregoing description.

In summary, therefore, the data shown for each entry is as follows:

- (a) Entry number;
- (b) Stock code;
- (c) Buy or sell;
- (d) Quantity;
- (e) Broadcast or discreet;
- (f) Price;
- (g) Price qualifier;
- (h) Expiry time;
- (i) Groups of subscribers to which the entry is accessible.

The signing on of a subscriber takes place without other subscribers being informed.

#### Page

To obtain the second page, the subscriber depresses key 200 to call up the proforma for the page facility, the following Table 2 is an example:

TABLE 2

PAGE	page-no	copy?
2		YES

Thus, having called up the appropriate proforma, the subscriber keys in the page number in the appropriate field and, if he requires his entries from the next page to be printed, then he keys in the word YES under the field headed "copy?". The central computer will then cause the second page to be displayed in area 142 of the screen, but for brevity then deleted are omitted from Table 2.

If the subscriber, when he signs on, has no current live entries when he signs on, the message "NO CURRENT LIVE ENTRIES" is displayed in area 142 of the screen. This will appear in line position 8 with the current time being indicated at the beginning of the line, for example:

5 09.45 NO CURRENT LIVE ENTRIES 5

It is considered unnecessary to describe and illustrate a flow chart for the above functions in signing on.

10 If the subscriber wishes to sign on in the training mode only, he would, following his password, have operated the separator key 176 and then keyed in the character "T", and if he did this he would, as previously indicated, be able to deal only in training stocks. 10

#### List

15 As has been indicated, signing on is achieved using the general command proforma called up by using the key 202. Another function which can be utilised with the aid of the general command proforma is to cause the system to list the subscriber's entries in a given stock at any particular time. This is achieved by keying into the field headed DETAILS firstly the word LIST, then a separator using key 176 then the stock code. The following Table is an example: 15

TABLE 3

GEN COMMAND DETAILS  
LIST#ICI

11.45 LIST	LIVE ENTRIES ON IMPERIAL CHEMICAL				
247/ICI	BUY	100,000*	DISCREET	@ 287	12.30
304/ICI	SELL	5,000+	BROADCAST	@ 290	12.15
215/ICI	BUY	10,000-	BROADCAST	@ 288	GTC

20 It is believed that detailed explanation of the above Table 3 need not be given as the meaning of the items in that table will already be apparent. 20

If there are no current live entries, the system will display the message, in area 142, "YOU HAVE NO ENTRIES IN THIS STOCK."

#### Sign Off

25 When a subscriber wishes to cease operations, he must sign off. This is also achieved by depressing the general command proforma key 202, keying in the message "SOFF", and the system then responds with an indication of the time and the message "SYSTEM PJCS SIGNED OFF", this response appearing in area 142 as usual. This can be better understood by reference to the following Table 4 illustrating signing off: 25

30 30

TABLE 4

GEN COMMAND DETAILS  
SOFF

16.00 SYSTEM	PJCS	SIGNED OFF
--------------	------	------------

When a subscriber is signed off, his terminal can, so long as it is switched on, receive messages from the monitor station, which are displayed in the central area 142; and broadcast messages, (i.e. messages sent to all subscribers), and messages indicating that an entry of the signed off subscriber has been located in a search by another, and such "search" messages are displayed in the lower area 144 of the screen of the display unit 128. Also messages can be sent to the monitor station. However, no other functions can be performed on the terminal until it is signed on. The signing off of a subscriber takes place without another subscriber being informed.

5

5

10

Quote

10

One of the facilities which the subscriber can make use of when he has signed on is the QUOTE facility. This is in two parts, called Parts 1 and 2. This facility enables the subscriber to obtain information about dealings in a specified stock, the information obtained being different in Parts 1 and 2. The following table 5 is illustrative of QUOTE Part 1:

15

15

TABLE 5

QUOTE	STOCK	PART	copy?
	BATS	1	
11.01 QUOTE PRICES FOR BRIT-AMERICAN TBAC			
	BUYERS	277	- 279 1/2
	SELLERS	280	- 282
	DEALT MAY	55,500 280 1/2	- 281 1/2
	DEALT APR	186,000 273	- 279

20

20

To use the QUOTE facility, the subscriber depresses key 184 on his keyboard and this causes the proforma for the QUOTE facility to be displayed in line position number 1 on his display unit screen. As can be seen from Table 5, the proforma displayed begins with the word QUOTE, underlined, indicating that this is the title of the facility which the proforma relates to. Thereafter there are three columns labelled respectively "STOCK", "PART" and "copy?". The subscriber has to key in the stock code in the column headed STOCK to designate the stock in which he is interested, the number 1 or the number 2 in the column headed PART to indicate whether he is interested in QUOTE Part 1 or QUOTE Part 2 and in the final column headed "copy?" he keys in the word YES if he requires the results of the QUOTE to be printed out on his printer; if not, then he keys ignores the column headed "copy?".

25

25

As can be seen from the above Table 1, in the example under discussion, the subscriber has typed in the stock code BATS, which is the code for British American Tobacco, and has indicated that he is interested in QUOTE Part 1.

30

30

Next the transmit key 216 of the subscriber's keyboard is depressed so that the instructions for carrying out the QUOTE facility for this particular subscriber are transmitted to the central computer 100.

35

35

The information which is provided by QUOTE Part 1 is the current price ranges of buy and sell offers in the book, and the quantity of the stock which has been dealt in, using the system, during the current month and the preceding month, together with the price ranges for each period.

40

40

Thus, the system responds, as shown in Table 5 by displaying in the area 142 of the screen, first of all the time at which the QUOTE was given, second the word "QUOTE", and thirdly the phrase "PRICES FOR BRIT-AMERICAN TBAC", all of this being in the uppermost available line of the screen, i.e. in the example line 6, which is immediately below the broken line 146.

The following four lines on the screen display respectively the price range of current buyers; the price range of current sellers; the quantity of British American Tobacco shares dealt in on the system in the current month, assumed to be May, and the range of prices obtained; and similar information for the preceding month, namely in this example April.

In order to make use of the facility QUOTE Part 2, it is not necessary for the subscriber again depresses his key 184, thus clearing the area 140 of his screen and displaying afresh the QUOTE facility proforma. All that is necessary is to overwrite the number 1 under the column headed PART, with the number 2. This is achieved simply by positioning the cursor over the number '1' to be overwritten then keying in the number '2'. In QUOTE Part 2, the information which the system provides is the quantity and price obtained for the latest four bargains which have been struck using the system in the stock in question. This information is displayed, as before, in area 142 of the screen on the subscriber terminal, for example as in the following table 6.

TABLE 6

QUOTE	STOCK	PART	copy?
	BATS	2	
11.03	BARGNS	LATEST FOR BRIT-AMERICAN TBAC	
		01/05	40,000 280 1/2
		01/05	15,500 281 1/2
		30/04	20,000 279
		29/04	32,000 278

As can be seen the heading which the system provides in response to the QUOTE Part 2 facility is firstly the current time and then the phrase "BARGNS LATEST FOR BRIT-AMERICAN TBAC". There then follows a list of the four latest bargains. In the list, the first item in each line is the date on which the bargain was struck; that is followed by the quantity of shares sold and the price obtained.

In the case of QUOTE Part 1, if the investigation carried out by the system reveals no buyers, no sellers, no dealings in the current month or no dealings in the preceding month, the word "NONE" is displayed on the screen in the relevant line following the relevant text.

For example:

BUYERS	NONE
SELLERS	NONE
DEALT MAY	NONE
DEALT APR	NONE

In the case of QUOTE Part 2, if there are no recent bargains to be displayed, then the words "NO RECENT BARGNS IN THIS STOCK" are displayed on the screen in area 142 underneath the heading "BARGNS LATEST FOR BRIT-AMERICAN TBAC".

In describing QUOTE Part 2 above, it was assumed, and has been shown in Table 6, that the information revealed is displayed in the upper portion of the area 142 of the screen, i.e. it has been assumed that area 142 was clear when QUOTE Part 2 was requested. If there was already information in area 142 when QUOTE Part 2 was requested, for example if QUOTE Part 2 was requested immediately after QUOTE Part 1, the system response to the QUOTE Part 2 request would be displayed underneath the QUOTE Part 1 information and, as has been previously explained, the lower boundary defined by line 148 of the area 142 would be shifted downwards to accommodate the extra information as necessary.

With reference to Figure 4, when the QUOTE facility is requested by a subscriber, the processor 102 of the central computer operates to transfer the relevant program from disc 114 to core memory 104, this being designated by the function "ENTER" which is the first operation performed in the flow chart of Figure 4.1, which operation is designated in Figure 4.1 by reference number 240. Thereafter initial checking takes place at 242, the system status, as to whether it is operating or not, is checked at 244 and the status of the subscriber requesting the facility is checked at 248; it will be recalled that subscribers may be subject to a "hold" whereby they are prohibited from making use of the facilities of the system. There are then further validation and checking procedures at 250 and 252. Assuming all checks are valid, the programme then proceeds to the next stage as indicated by the reference character A at the bottom of Figure 4.1. As can be seen, the same reference character appears at the top of Figure 4.2 meaning that Figure 4.2 follows on from Figure 4.1. Thus the next stage 254 is to read the stock file from unit 106 into the core memory 104. At stage 258, the processor 102 builds a report for off-line purposes; this report indicates that a subscriber has made use of the QUOTE facility on this particular stock and is simply for record purposes. At 260, the computer takes a decision as to whether, on the basis of the information transmitted to it from the subscriber terminal, QUOTE facility Part 1 or Part 2 is required. It will be assumed initially that Part 1 is required and accordingly the next stage is the setting up of the headings to be displayed in area 142 of the subscriber's screen in response to a request for the QUOTE Part 1 facility. Next, the central computer sets up a "BUY" flag at 264 to enable it first to locate offers to buy in the stock file.

As indicated by reference character B, the programme then continues onto Figure 4.3 and, at 266 sets up the word "BUYERS" which is to be displayed in the second line of the system response information (see Table 5). At the next stage 268, the processor 102 takes a decision as to whether all entries in the stock file which has been obtained have yet been checked. The answer to this will, at this time of course be NO since so far no entries have been checked, and therefore the programme moves to the stage 270 at which the first entry is obtained and a decision is taken as to whether it is to be processed. Examples of reasons why a particular entry might not be processed are that it has been traded, or that it has time expired.

Assuming that the entry is to be processed, a decision is taken at 272 as to whether the BUY flag is set. As has been indicated above, the BUY flag is in fact set and thus the programme proceeds, as shown at 274 to a stage at which a decision is taken as to whether the entry being checked is or is not a BUY.

Assuming that the entry being checked at 274 at this time is a BUY, the programme proceeds as indicated by reference character C to stage 276 at which the price of the entry currently being checked is compared with the previously found minimum and maximum prices. When the first entry is being checked, there will of course be no previous minimum and maximum and therefore the system will simply store the address of the current entry for use in comparing its price with the price of the next entry to be checked. Thereafter, as shown at 278, the addresses of the minimum and maximum price entries will be updated, if necessary, as a result of the comparison which takes place at 276. After this updating, the next entry is obtained at 280 and the programme returns to point B1 in Figure 4.3 which is immediately preceding stage 268. Thereafter the foregoing stages 268 to 280 are repeated.

In the event that stage 270 or 274 results in the decision being NO, that is to say either the entry is not to be processed or it is not a BUY entry, then the programme jumps, as indicated by reference number C1, to the point C1 in Figure 4.4, so that the next entry is immediately obtained.

Eventually all entries will have been checked and this will be revealed by stage 268, in which case the programme moves on, as indicated by reference character D to Figure 4.5.

In Figure 4.5, the first stage is to take a decision as to whether entries were found and this is indicated by reference number 282. If the answer is YES then the processor 102 sets up the line of data to be displayed (reference may be made back to Table 3 in this regard) as indicated at 284. If the answer to decision 282 is NO, then the central processor 102 sets up the word "NONE" to be displayed as shown at 286.

Next, the central processor decides, at 288 whether the BUY flag is set. At this stage, in the present example, under discussion the BUY flag is set and so the

5 programme proceeds to stage 290 at which the first entry in the stock file is again  
 obtained, and, as shown at 292, a "SELL" flag is set up by the processor 102 and  
 then the program returns to point B in Figure 4.3. Then the word "SELLERS" is set  
 up at stage 266 for display in the third line of the system response information  
 which is to be given to the subscriber in the QUOTE facility. The operations  
 previously described are then repeated until decision 272 is reached. The answer to  
 decision 272 in this case, since the SELL flag is now set, will be NO and accordingly  
 the program proceeds to decision 294 at which it is determined whether the entry is  
 a sell offer. If it is, the program proceeds to point C and to the comparison and  
 10 updating of stages 276 and 278; if it is not, then the program proceeds to point C1,  
 at which the next entry is obtained. 10

15 The operations described above are then repeated until again the program  
 comes to point D and, having gone through stages 282 and 286 or 284, the decision  
 288 will now indicate that the BUY flag is not set and so the program will proceed  
 to point E and at 296 the cumulative entries of dealings in the stock in question  
 during the current and preceding months respectively are set up. 15

20 At 300 the message for display on the terminal screen is transmitted. At 302 a  
 message is sent to the monitor station, and to the store 110, in order to indicate to  
 the monitor station, and to create a record of, what operation has just taken place  
 on the system by this subscriber. At 304, the stock book is released from the core  
 memory, and at 306 the program for QUOTE exists. 20

25 If the decision at 260, Figure 4.2, was that the request to the subscriber is not  
 for QUOTE Part 2, the programme proceeds to point F in Figure 4.7.

25 In Figure 4.7, a decision is taken at 281 as to whether all entries have been  
 checked. Of course, when the first entry is being checked, the answer will be NO  
 and therefore the programme proceeds to 283 at which a decision is taken as to  
 whether the entry being checked is traded or not. If it is traded, details of it are  
 entered into a store and, when subsequent traded entries are found the store is  
 updated, as necessary, so that it stores only the four most recent trades, as in-  
 30 dicated at 285. After the update at 285, or if the answer to decision 283 is no, the  
 programme proceeds to 287 at which the next entry is obtained and then it returns  
 to 281. When all entries have been checked i.e. the answer to decision 281 is YES,  
 the programme moves on to G of Figure 4.8. In Figure 4.8, the first function is to  
 decide whether any traded entries have been found, this being indicated at 289. If  
 35 the answer is YES, the traded entries are moved at 291 to an output area of the core  
 104; if the answer is NO, the phrase "NO RECENT BARGNS" is inserted in the  
 output area of the core 104, as indicated by the reference character 293 in Figure  
 4.8. Thereafter, the programme moves to E1 in Figure 4.6 and functions already  
 described take place. 35

40 The information which is supplied to the monitor station 124 and to the  
 magnetic storage unit 110 for record purposes is as follows: 40

- (a) The time at which the facility was used;
- (b) The monitor slip number;
- (c) The subscriber reference number;
- 45 (d) An indication of whether the QUOTE was Part 1 or Part 2, this being given  
 by the abbreviation "PRCE" of the word "price" if Part 1 and the abbreviation  
 "TRAD" of the word "trade" if Part 2 was requested;
- (e) The letter "C" if hard copy was requested by the subscriber;
- (f) The stock code of the QUOTE requested. 45

50 Other subscribers are not informed when one subscriber uses the QUOTE  
 facility. 50

#### Search

55 A further facility which the system provides will be referred to as the SEARCH  
 facility. This enables a subscriber who wishes to deal in a certain quantity of stock  
 at or about a certain price to obtain from the system a list of any expressions of  
 interest which have been entered into the system by other subscribers and which  
 are compatible with the first subscriber's requirements. When such compatible  
 entries are found, the subscribers may enter negotiations with each other. 55

The following Table 5 illustrates an example of the SEARCH facility:



TABLE 7

SEARCH	STOCK ICI	B/S BUY	QUANTITY 60000-	PRICE 288	xdr	excl.grps	dcr? YES
09.48	SEARCH MATCH ON		60,000-	IMPERIAL CHEMICAL@			288 P1/2
2367	SELLER OF		50,000+	@			292
2368	SELLER OF		100,000-	@			291
2369	SELLER OF		LESS+	@			293
2370	SELLER OF		MORE-	@			289

In order to make use of the SEARCH facility, the subscriber depresses key 186 on his keyboard and this causes the appropriate proforma to be displayed in area 140 of his screen, in line position number 1. The proforma is shown in Table 7. As usual, there is included, at the left hand end of the line, the title of the facility being requested.

Under the column headed STOCK in the proforma, the subscriber keys in the stock code, in this case ICI meaning Imperial Chemical Industries. Under the next column headed B/S, the subscriber keys in the word "BUY" or "SELL" to indicate whether he wishes to buy or sell stock. A single depression of the tabulation key 214 will cause the cursor to move to the first character position of the next column and thus, after keying in ICI the subscriber would normally press the tabulation key 214 once and then proceed immediately to key in the appropriate word under the next column.

In the column headed QUANTITY, the subscriber must key in an indication of the quantity of stock which he wishes to buy or sell. The quantity is keyed in in numeric characters and this must be followed by either a plus sign (+), obtained by depressing key 164, to indicate that the subscriber would be prepared to deal in quantities greater than that specified; or a minus sign (-) obtained by depressing key 166 which indicates that the subscriber would be prepared to do less than the quantity specified; or an asterisk (\*) obtained by depressing key 168 which indicates that the subscriber wishes to deal in the exact quantity specified.

In the next column, which is headed PRICE, the subscriber keys in the price he wishes to pay if he is intending to buy shares or the price he wishes to obtain if he is intending to sell. From the above description, it will be now clear that in the example illustrated in Table 7 the subscriber wishes to buy 60,000 or less shares in ICI at a price of 288.

The next column in the proforma is headed xdr. This is for the subscriber to indicate whether he wishes to deal ex dividends, rights or capitalisation, this indication being achieved by keying in, in this column, XD, XR or XC respectively. The subscriber may leave this column blank, but if it is filled in, the system will check whether such dealings in the particular security are currently permitted. Reference may be made to the foregoing description of the stock data held for further information on this point.

The next column in the proforma is for the subscriber to indicate whether he wishes to exclude any particular groups of other subscribers, such as merchant banks or insurance companies. If this is not filled in, the search will be made amongst all groups.

The final column in the search proforma is for the subscriber to indicate whether he wishes the search to be carried out discreetly. If discretion is required, then the word YES is keyed in in this column, as is shown to be the case in the example of Table 7. If the subscriber does not wish his search to be carried out discreetly, he leaves the final column blank, in which case both the quantity and price parameters keyed in by the subscriber doing the search will be transmitted by the central computer 100 to any other subscriber who has a compatible entry located by the system in response to the search request. If, on the other hand, the subscriber requesting the search requests discretion by keying the word YES into

the final column of the proforma, then, although the central computer 100 will inform subscribers having compatible entries that their entries have been located in a search, the exact quantity parameter specified by the searcher will not be usually given to these other subscribers.

5 When the subscriber requesting the search has filled in the proforma, he presses his transmit key 216 so that his request is transmitted to the central computer 100. Confirmation that the computer 100 is responding, and the time, are displayed in area 142 of the screen. Compatible entries are displayed also in area 142 as shown in Table 7. At the end of the first line of area 142 as shown in Table 7, the characters P 1/2 appear to indicate that the list of four entries given is the first page only and that there are more entries to be obtained by using the PAGE facility, i.e. pressing key 200 and entering data as previously described.

10 In the example of Table 7, the first compatible entry given is a seller of 50,000 or more ICI shares at 292, the number 2367 given at the beginning of the relevant line being a contact number for enabling the subscribers to make contact with each other anonymously for negotiation purposes. The next compatible entry is a seller of 100,000 or less at 291. The next indication which reads "LESS+" at 293 means that the subscriber who made that entry did it without broadcasting the entry i.e. he requested discretion when entering the book (this will be described in further detail subsequently) and accordingly although his entry is located by the search, the exact quantity parameter is not disclosed to the searcher. The word LESS means that the exact quantity parameter of the entry is less than the 60,000 put in by the searcher and the plus sign (+) following the word LESS means that the subscriber having that entry is prepared to deal in greater quantities than specified by his quantity parameter. Of course, if the quantity parameter of the entry were less than the 60,000 put in by the searcher, and the quantity qualifier of the entry were a minus sign instead of a plus sign, indicating that the entry is prepared to deal in his specified quantity or less, then that entry would also have been compatible with the 60,000— inserted by the searcher.

20 The fourth entry listed in Table 7, it would probably now be recognised, is an indication of a discreet (i.e. non-broadcast) entry having a quantity parameter greater than 60,000 but with a price qualifier of minus so making this entry compatible with the 60,000— specified by the searcher.

25 It was mentioned above that the subscribers having the entries located by a search are informed that their entries are being so located. Taking the last entry on the list of Table 5 as an example, the subscriber of that entry will have displayed on his screen, in the bottom area 144, the data in the following Table 8.

TABLE 8

09.48 \*\*2370 BUY LESS— IMPERIAL CHEMICAL@ 288  
SEARCHING YOUR 80,000—more-shown @ 289 16.00

40 The data of Table 8 will be added underneath any existing data in area 144, existing data in this area being scrolled upwardly to remove the uppermost lines to make space for the two new lines of data, if area 146 is already full.

45 In the first line of the data of Table 8, 09.48 indicates the time of the search, the double asterisk (\*\*) is an alert to the subscriber receiving Table 8 that this particular message concerns him specifically thus distinguishing it from broadcast messages (in addition, an audible alert is preferably sounded at the subscriber station receiving Table 8); next the word BUY indicates that the search being reported is by someone wishing to buy shares; LESS— indicates that the quantity specified by the searcher is less than the quantity specified in the entry, and the symbol minus (—) indicates that the searcher is prepared to deal in even less; and the remainder of the first line identifies the stock and the price. It may be noted that the expression LESS—, rather than 60,000—, appears in the first line of Table 8 because the searcher has requested discretion as shown in Table 6.

50 The second line of Table 8 identifies to the subscriber whose entry has been located exactly which entry it is, it being assumed in Table 8 that the entry in question is an offer to sell 80,000 or less ICI shares at 289 and that the offer expires at 16.00. The words "more-shown" indicate that the entry has been displayed to the

searcher as MORE, rather than the entered quantity of 80,000 specified in the entry.

In Table 7, only a selected number of compatible entries have been shown. Another form of compatible entry would be one stating a quantity less and prepared to do less than the 60,000 specified by the searcher (e.g. 40,000—). The search would also of course disclose any "ALL OR NONE" entries equal to or less than the 60,000 specified by the searcher i.e. an entry such as 45,000± since that also is compatible with the 60,000— specified by the searcher.

In the case of a search quantity specified as "ALL OR NONE" by an asterisk, e.g. 60,000\* , the search will disclose not only entries of precisely 60,000, but also those of a quantity LESS+ or a quantity MORE—, and also any "ALL OR NONE" entries ( ± ) within 15% of which the searcher's 60,000 \* falls, since it is considered that such entries, although not exact, are sufficiently close to make it feasible that negotiations might take place. Of course other percentages might be chosen, such as 10%.

Where compatible "ALL OR NONE" entries which are discreet (i.e. non-broadcast) are located in a search, the searcher will only find that entry if he searches in the identical quantity.

The following Table 9 will summarise the way in which the determination of whether an entry is compatible with a search is determined:

TABLE 9

ENTRY QUALIFIER	SEARCH QUANTITY VS ENTRY QUANTITY	SEARCH QUALIFIER		
		—	*	+
—	Less	Y	Y	Y
—	Equal	Y	Y	Y
—	Greater	Y	N	N
*	Less	N	See Below Text	Y
*	Equal	Y		Y
*	Greater	Y		N
+	Less	N	N	Y
+	Equal	Y	Y	Y
+	Greater	Y	Y	Y

The left hand column of Table 9 indicates the qualifier attached to the quantity specified in the entry which is already in the book. The middle column states whether the quantity specified by the searcher is less than, equal to or greater than the quantity specified in the entry being examined; and the three right hand columns indicate whether compatibility for the three possible different qualifiers attached to the quantity specified in the search request. A capital letter Y indicates that compatibility exists and N indicates no compatibility.

Regarding the middle three situations in the middle of the last three columns, compatibility will only exist if:

$$0.85 \times \text{Entry quantity} \leq \text{Search quantity} \leq 1.15 \times \text{entry quantity}$$

This inequality of course represents the 15% range above-mentioned.

After it has been determined whether a match situation exists, it is necessary to determine, in dependence upon whether the entry located is discreet or not, i.e.

whether or not it was broadcast, and in dependence upon the quantity qualifiers of the entry located and of the search request, whether the entry located is to be displayed openly (i.e. with an indication of the quantity specified in the entry) or discreetly (i.e. with the word MORE or LESS in place of the quantity), or in some situations whether the entry will be displayed at all. The following Table 10 will summarise the possible situation and the decision taken:

TABLE 10

ENTRY DATA		SEARCH QTY : ENTRY QTY		
BCAST?	QTY.QUAL.	EQUAL	WITHIN±15%*	BEYOND±15%*
NO	±	O	O	D
NO	*	O	N	N
YES	ANY	O	O	O

In the above table, the two left hand columns indicate respectively whether the entry which is being considered was broadcast or not and the quantity qualifier attached to the quantity specified in the entry. The three right hand columns indicate what kind of message is displayed to the searcher according to whether the quantity specified in the search and the quantity specified in the entry are equal, within + or - 15%, or outside 15% respectively. In the three right hand columns, the symbol O means an open message is sent to the searcher i.e. the actual quantity specified in the entry is provided to the searcher, the symbol D means a discreet message is sent i.e. the quantity of the entry is not specified, and the symbol N means that no message is sent, i.e. the searcher will not be informed of the entry at all. The 15% referred to in the table is the same as that discussed previously, namely entry quantity + or - 15% of the entry quantity. This may be expressed as follows:

$$\frac{\text{SEARCH} - \text{ENTRY}}{\text{ENTRY}} \times 100$$

Thus, reading along the first line of data in the above Table 10, it can be seen that for a discreet entry (i.e. no broadcast) having a quantity qualifier of + or -, an open message will be sent to the searcher if the search quantity is equal to or within the 15% limit; but if the search quantity is beyond the 15% limit then a discreet message is sent to the searcher.

As seen from the second line of Table 10, if the entry was not broadcast and if the quantity qualifier is \* then an open message is sent to the searcher if the quantities specified in the search and in the entry are equal, but otherwise no message is sent to the searcher.

The last line of Table 10 indicates that if the entry was broadcast then, regardless of its quantity qualifier, an open message is sent to the searcher.

It will therefore be recognised that in Table 7, of the entries displayed to the searcher, those identified by contact numbers 2367 and 2368 fall into the category defined by the last line of Table 10 whereas those identified by contact numbers 2369 and 2370 fall into the category identified by the symbol D in the right hand column of the first line of data in Table 10.

Even though in two of the cases identified in Table 10 (middle line, fourth and fifth columns) the subscriber making the search is not informed of the entry, the subscribers of all entries compatible with the search request are informed that their entry has been searched. The message sent to the subscriber who made the entry

will be open if the searcher has not requested discretion i.e. his actual specified size will be displayed, but if the searcher has requested discretion an open message will be sent to the subscriber having the compatible entry only if the search quantity is equal to the entry quantity or within  $\pm 15\%$  as defined above, otherwise a discreet message will be sent to the subscriber who made the relevant entry. The following Table 11 summarises this:

TABLE 11

DISCRETION REQUESTED BY SEARCHER	SEARCH QTY	cf	ENTRY QTY
	WITHIN 15%		BEYOND 15%
YES	O		D
NO	O		O

The symbols O and D have the same meaning as in Table 10.

The message sent to the subscriber having the entry is a two line message as shown in Table 8, from which it will be apparent that the message sent to the subscriber whose entry is identified by contact number 2370 falls within the category defined by the symbol D in the right hand column of the first line of the above Table 11.

As previously indicated, the subscriber having the entry located by the search is also told what has been shown, concerning his entry, to the searcher. In Table 8, therefore, the message "MORE-SHOWN" indicates that a discreet message was sent to the searcher.

In the case of either of the situations of Table 10 in which no message is sent to the searcher, the subscriber responsible for the relevant entry is informed of this by the message "NOT SHOWN" being displayed on his screen. If an open message is sent to the searcher, then the subscriber having the entry is informed of this by the message "FULLY SHOWN" being displayed on his screen.

In all cases where the system decides, using the criteria of Table 9, that an entry is compatible with a search request, a contact number is allocated to the entry. Where both subscribers are informed of the compatible situation, then either can initiate negotiations using the contact number. Where only the subscriber having the entry is informed of the compatible situation then it is up to him to initiate negotiations if he wishes.

Where no compatible entries are located or none are displayed to the searcher, the message "NO SUITABLE MATCHES AT PRESENT — TRY MAKING AN ENTRY" is displayed to the searcher on his screen immediately under the line concerning his search request.

The flow chart of Figure 5 illustrates the functions which take place in the central computer 100 in response to a search request. At 308, the programme is entered into the core memory 104 from the disc storage unit 114 and initialisation procedures take place at 310. At 312 a decision is taken as to whether the system is "logged on" i.e. whether it is actually open for business. At 314, a check is made as to whether the physical and logical subscriber are valid i.e. subscriber status check. The significance of reference to physical and logical subscriber is that the system is set up so that if for any reason, such as due to a terminal fault, a particular subscriber is unable to operate directly into the system, the operators of the monitor station can act on his behalf. In such a case, the monitor station would be the "physical" subscriber but the logical subscriber would still be the actual subscriber who wishes the particular facility to be made use of.

At 316 the validity of the message is checked and at 318 a decision is taken as to whether the stock record is live i.e. whether the stock specified in the search request is handled on the system.

Assuming the answer to each of the decisions so far described in Figure 5.1 is YES, the programme proceeds to point A still in Figure 5.1 and at 320 the system determines whether the stock record is compatible with the subscriber i.e. if subscriber is signed on for training he can only deal in training stocks, or if he is signed on for dealing in real stocks then he can only deal in real stocks. At 322 the system translates the input price data into appropriate form for use in the system (it will be recalled that prices input can be in different forms, but once input into the system, the prices are all dealt with in the same way). At 324, the total consideration for the search request (i.e. quantity times price) is worked out and the determination is made as to whether the system can handle such a consideration. For example, the system may have limits for the maximum and minimum consideration to be handled, but in any event there will be an absolute maximum consideration which can be handled by the system depending upon the physical constraints of the system i.e. size of storage area or registers etc.

At 326, a decision is taken as to whether the price qualifier (i.e. cum or ex dividend, rights or capitalisation) of the stock in question is compatible with any qualifier specified in the search request.

If the answer to any of the decisions illustrated in Figure 5.1 is NO, then the programme proceeds to point L in Figure 5.5 and any stock or subscriber records transferred to the core memory are released i.e. removed, at 330, an error message is compiled and sent to the subscriber at 332 indicating to him why his request cannot be handled, and the programme is exited at 334.

However, if all decisions illustrated in Figure 5.1 result in a YES, then the programme proceeds to point B in Figure 5.2 for the checking of the entries in the selected stock book to locate any entries compatible with the search request. At 336, the first entry is selected and at 338 a decision is taken as to whether the details are compatible with the search, in particular whether the entry belongs to a subscriber who falls within a group excluded in the search request or, conversely, if the searcher falls within a group excluded by the entry; and, if the searcher wishes to BUY, then only entries which constitute offers to sell will be compatible. If the first entry is incompatible i.e. decision 338 results in a NO, the programme moves to point C in Figure 5.2 and a decision is taken as to whether the last entry has been processed, at 340. Assuming there are further entries, the programme then returns to point D in Figure 5.2 and the next entry is checked for compatibility at 338.

When the decision at 338 is YES, a decision is taken at 342 as to whether the quantity qualifiers (i.e. +, - or \*) are the same.

If the answer to decision 342 is NO, then, as shown by 344 and 346, if the entry qualifier is minus (-) and the search quantity is greater than the entry quantity, indicating incompatibility, the programme proceeds to point C as before. Compatibility is indicated, however, by the result of decision 346 being NO, in which case the programme proceeds to point E.

If the decision at 344 is NO, then decision 350 determines if the entry qualifier is plus (+), and if it is, decision 352 determines compatibility or otherwise by determining whether the search quantity is less than the entry quantity and moves the programme on to point E or point C accordingly.

If the decision at 350 is that the entry qualifier is not plus (+), then a decision is taken at 352 as to whether the search qualifier is minus (-), and if it is decision 354 determines compatibility or incompatibility by deciding if the search quantity is less than the entry quantity, and the programme proceeds to point E or point C.

If the answer to decision 352 is NO, then a decision is taken at 356 as to whether the search quantity is greater than the entry quantity and if the answer to this is NO then the entries are compatible and the programme proceeds to point E and if the answer is YES the entries are incompatible so the programme again proceeds to point C.

If the answer to decision 342 was YES, then decision 358 determines whether the qualifiers are all or none as indicated by an asterisk (\*). If the qualifiers are not \* i.e. both are + or both are -, then the entries will be compatible and the programme will proceed to point E. If both qualifiers are \* then the entries will only be compatible if the search quantity is within the 15% limitation above discussed, and this decision is taken at 360 and the programme proceeds either to point C or point E according to whether the answer is NO or YES respectively.

Accordingly, the flow chart of Figure 5.2 implements the selection criteria defined in Table 9.

Compatible entries are therefore further processed in order to implement Tables 10 and 11. In such cases, the programme proceeds to point E in Figure 5.3

and first a decision is taken at 362 as to whether the quantities specified in both search and entry are equal. If they are, then, as shown at 364, the central processor records that no discretion is required to either party and the programme proceeds to point G which then leads to point J of Figure 5.4 and, at 366 an appropriate entry is built by the processor. Thereafter, the programme returns to point C of Figure 5.2

If decision 362 reveals that the quantities are not equal, then, as shown at 368, if the entry was broadcast and the search is without discretion, the programme again proceeds to 364. If, however, the entry was not broadcast and/or the search is with discretion, the programme proceeds to 370 at which the following calculation is performed:

$$\frac{\text{SEARCH QTY} - \text{ENTRY QTY}}{\text{ENTRY QTY}} \times 100$$

After the calculation has been performed, decision 372 determines whether the result is less than or equal to 15. If it is, then, firstly, the central computer records at 374 that an open message is to be sent to the subscriber who made the entry (see Table 11, centre column). Then, to determine the kind of message, if any, to be sent to the searcher, the central computer executes decision 376, namely if the entry qualifier is \* and the entry was not broadcast, (Table 10 line 2 column 4) the searcher will not be informed of the entry, and this fact is recorded by the computer at 378. If, however, decision 376 reveals that the entry qualifier is not asterisk (\*), (that is to say the entry qualifier is either plus or minus) and/or that the entry was broadcast, then an open message is to be sent to the searcher, this being recorded by the central computer at 380. From points 378 and 380, the programme proceeds to point J.

If decision 372 reveals that the search quantity specified is not within the 15% limitation, the programme proceeds to point F and a decision is taken at 382 as to whether the search is discreet or not. If it is not discreet, then the computer records this at 384 i.e. an open message will be sent to the subscriber whose entry has been located by the search. Then, to determine what kind of message, if any, will be sent to the searcher, decision 386 determines whether the entry quantity qualifier is asterisk (\*): if it is, then no message is to be sent to the searcher and this is recorded by the computer at 388 and if it is not, then the computer records that a discreet message is to be sent to the searcher. The programme then proceeds to joint J.

If the decision 382 reveals that the search is in fact discreet, then the programme proceeds to point H in Figure 5.4 and, firstly, the computer records at 385 that a discreet message is to be sent to the subscriber whose entry has been located.

Then the programme proceeds to determine what kind of message is to be sent to the searcher. Firstly decision 387 determines whether the entry was broadcast. If it was, then an open message is to be sent to the searcher and this is recorded by the computer at 389.

If the entry was not broadcast, decision 391 determines whether the qualifier of the entry quantity is asterisk (\*). If it is, then no message is to be sent to the searcher and this is recorded at 393. If the entry qualifier is revealed not to be asterisk (\*) by decision 391, (i.e. the entry qualifier is either plus or minus), then a discreet message is to be sent to the searcher and this is recorded by the computer at 395.

After the computer has recorded the appropriate information according to 389, 393 or 395, the subscriber entry is built at 366 and the program returns to point C in Figure 5.2.

After all entries have been processed, as determined by decision 340 of Figures 5.2 then the program proceeds to point K in Figure 5.5

Firstly, in Figure 5.5 the subscriber data is updated at 396, to prepare information for subsequent use by the page facility, then the stock record is released at 398, then at 400 the first live subscriber entry (if any), that is to say the first of the compatible entries, is selected for the purpose of building the message to be sent to the searcher.

A contact record is built at 404 and written at 406. Then a decision is taken at 408 as to whether the last of the compatible entries has been processed; if not, the program returns to stage 404. Once the last compatible entry has been processed at

408, the program moves to point M and a report data block is set up in preparation for sending out reports as indicated at 410. At 412, a report of the first four matches is sent to the searcher. At 414 a decision is taken as to whether any compatible entries were found. If so, the first compatible entry is selected at 416 and the appropriate message is built and sent, as indicated at 418, to the subscriber who made that entry. At 420 a decision is taken as to whether the last compatible entry has been processed. If not, the program returns to 418, for selection of the next entry and building and sending of a message to the subscriber who made that entry.

When the last entry has been processed as indicated by decision 420, or if decision 414 indicated that there were no compatible entries, the programme then proceeds to 422 at which a message is built and sent to the monitor and to the log file storage unit 110, and at 424 the updated subscriber record is written in the disc storage unit 108.

At 426 the program exits.

The data sent to the monitor is in two lines and is as follows:

Line 1:

- (a) Time at which the entry was made;
- (b) Monitor slip number;
- (c) Logical subscriber reference number;
- (d) Transaction descriptor (SRCH);
- (e) Literal "D" for discreet, or "O" for open;
- (f) The subscriber groups who may be alerted to the search, else "ALL SUBS"
- (g) "B" for buy, "S" for sell;
- (h) Quantity;
- (i) Stock code;
- (j) Price;
- (k) Price qualifier.

Line 2:

- (a) The number of contacts found;
- (b) Literal "FROM" and the first allocated conversation number;
- (c) List of subscriber numbers alerted.

This same data is sent to the magnetic disc storage unit 110.

#### Enter Book

If a subscriber wishes to enter an expression of interest into the book on a particular stock, he first depresses the key 188 on his keyboard. This clears the area 140 of his screen and causes the appropriate proforma for ENTER BOOK to be displayed. He then keys in the appropriate information in the appropriate places as defined by the proforma, and depresses his transmit key 216 and, as with the other functions, confirmation that his message has been accepted by the central computer is displayed in area 142 of his screen.

The following Table 12 illustrates an example of ENTER BOOK:

TABLE 12

ENTER BOOK	STOCK	B/S	QUANTITY	PRICE	xdrc	expiry	excl.grps	dcr?
	ICI	BUY	60000-	288		1600		

09.51	ENTRY	BROADCAST TO ALL SUBS						
	331/ICI	BUY	60,000-	IMPERIAL CHEMICAL	@ 288	16.00		

As can be seen the proforma includes first of all the title of the function, then columns for entering the stock code, whether the entry is an interest to buy or an offer to sell, the quantity of stock, the price, the price qualifier (xdrc) as previously described, a column headed "expiry" which is for an indication of the time at which the entry will expire and then columns for indicating excluded groups of subscribers and whether the entry is to be discreet. If the column headed dcr?, for discreet, is left blank then the entry will be broadcast; if it is to be discreet then the word YES will be keyed in this column.



As can be seen, in the example the interest is to buy up to 60,000 ICI shares at a price of 288 and it will expire at 16.00 (4 pm). There are no price qualifiers and no excluded groups and the entry is to be broadcast.

5 As can be seen in the confirmation message displayed, the message was transmitted at 09.51, the message was an entry and it was broadcast to all subscribers (ie: no excluded groups of subscribers but had there been excluded groups, the groups to which the entry is accessible would be indicated). This information is all in the first line of the confirmation message. The second line gives first of all the entry number as 331 followed by the stock code ICI, then details of the offer and the time of expiry. 5

10 Since the entry has been broadcast, all other subscriber terminals which are switched on would receive it in areas 144 of their screens. The message was displayed in areas 144 is as follows: 10

09.51 331/ICI BUY 60,000- IMPERIAL CHEMICAL @ 288 16.00

15 If the entry had included a price qualifier, this would have been indicated in the broadcast message. 15

Any subscriber who already has an entry in the book of the relevant stock (in this case ICI) will receive an audible alert from his terminal and two asterisks will appear in front of the entry number as follows: \*\* 331/ICI. Subscribers who are alerted in this way will also have the message automatically printed out by their printers 130, even if the subscriber has not requested hard copy of broadcasts. 20

Also an ENTER BOOK message is automatically printed out by the printer 130 of the subscriber who is entering an offer into the book.

25 Figure 6.1 is a flow chart illustrating the functions which take place in the central computer 100 when a subscriber enters an offer into the book. At 430 in Figure 6.1, the relevant program is entered into the core memory 104, initialisation is carried out at 432, the system and the subscriber status are checked at 434 and 436, the validity of the message received from the subscriber is determined at 438 and a decision as to whether any errors exist in the message is taken at 440. Then the stock record is checked at 446, the price format at 448, the consideration at 450, the price qualifier at 452, and the expiry time at 454. Assuming all are found to be correct, then the programme proceeds to point 456 at which an entry in the book is selected for overwriting. This involves examining existing entries in the book to find one which need no longer be kept, for example an entry which has expired or one which has been traded and whose trade no longer needs to be held. 30 There is then a check at 458 to determine whether the book is full and whether the subscriber has already made the maximum number of allowed entries on the stock in question; for example, the system may limit subscribers to no more than two entries on each side (buy or sell) of the book on each stock. Assuming no errors are found, the new live entry is set up at 460, an off-line report is built at 462 and the confirmation message regarding the entry sent to the subscriber who entered it at 464. 35

40 The program then proceeds to point B on Figure 6.2. At 466, data concerning the entry is sent to the monitor, at 468 a decision as to whether the entry is to be broadcast is taken. If broadcast is required, then the broadcast is built and sent at 470. Then, at 472 the stock record is updated with the new entry, the subscriber record is released at 474 and the program returned at 476. 45

50 If decision 434 or 436 indicates that the system or subscriber status is inappropriate (e.g. the system is not open for business in the case of decision 434, in the case of 436, the subscriber is making an entry in respect of real securities whereas he is only signed on for training or vice versa), or if any errors are found at decision 440, the program proceeds to point C in Figure 6.2 and the error handler program is called at 478. The program is then returned to storage at 476. 50

55 Also, if decision 446 reveals that the stock record is not in order then a decision is taken at 480 as to whether the problem is merely a failure in reading the record; if it is, the program again proceeds to point C. If the problem is not in reading the record, but there is actually a problem with the record itself (for example the record does not yet hold data for the stock), then the program proceeds to point D in Figure 6.2 and the stock record is released at 482 before the error handler is called at 478. 55

60 Similarly, if any of decisions 448, 450, 452 and 454 result in a NO, the program 60

proceeds to point D. If decision 458 reveals that there are any errors, then the program proceeds to point D.

The information which is supplied to the monitor station 124 and to the storage unit 110 is as follows:

- |    |  |    |
|----|--|----|
| 5  | (a) The time at which the entry was made;                            | 5  |
|    | (b) The monitor slip number;   |    |
|    | (c) The logical subscriber reference number;                         |    |
|    | (d) The word "ENTRY", which is an abbreviation for the word "entry"; |    |
| 10 | (e) "B" if broadcast, or "D" if discreet;                            | 10 |
|    | (f) The subscriber groups to whom the entry is accessible or "ALL";  |    |
|    | (g) "B" for buyer or "S" for seller;                                 |    |
|    | (h) Quantity;  |    |
|    | (i) Price;   |    |
| 15 | (j) Price qualifier;   | 15 |
|    | (k) Expiry time.   |    |

#### Alter Book

If a subscriber wishes to alter an entry which he has already made in a book, he may do this using the "ALTER BOOK" facility. To use this facility he first depresses the key 190 on his keyboard to call up the appropriate proforma, then, as usual, he keys in the appropriate information, presses the transmit key and the system alters the entry and confirms this to the subscriber. Altering an entry already made can be effected discreetly or it can be broadcast. The following Table 13 illustrates an example:

TABLE 13

ALTER BOOK	ENTRY STOCK	quantity	price	xdr	expiry	excl.grps	dcr
301	BATS		280				

09.25 REVISN BROADCAST TO ALL SUBS  
301/BATS SELL 80,000+ BRIT-AMERICAN TBAC @ 280 GTC

The first column, following the title of the facility, is headed "ENTRY" and in this column, the subscriber must key in the number of the entry which he wishes to alter, in this case 301. In the next column headed STOCK, he keys in, as usual, the stock code. When using the ALTER BOOK facility it is possible to change the entry data of any of the remaining columns but information is only keyed into those of the remaining columns in which the data is to be changed. Thus, the only change to be made in this example, is in the price and the subscriber keys in the new price at which he wishes to deal; thus, the quantity, the price qualifier, the expiry time, the excluded groups and the discretion status remain unchanged.

The confirmation message which appears in area 142 of the screen after the transmit key has been depressed begins with the current time, then the literal "REVISN" appears, being an abbreviation of the word revision meaning that the message is revising i.e. altering an entry in the book. Next there is an indication that the revision is being broadcast to all subscribers (i.e. there are no excluded groups). The second line of the confirmation message gives full details of the entry as revised, namely it is entry number 301 for British American Tobacco and it is an offer to sell 80,000 or more at a price of 280, and the offer will remain good till cancelled.

A confirmation message will be automatically printed out on the subscriber's printer.

In addition, since the revision is being broadcast, details will be displayed in areas 144 of all other subscriber terminals which are switched on, this display being as follows:

09.25 301/BATS R SELL 80,000+ BRIT-AMERICAN TBAC @ 280 GTC

In this display, the character R which precedes the word "SELL" indicates to the other subscribers that this is a revision of an entry and not a new entry.

As with an original entry, any subscriber who has an entry in the book for the same stock will receive an audible alert, two asterisks will precede the entry number in the message displayed in area 144 of his screen, and the broadcast will automatically be printed out on that subscriber's printer.

Figure 7 is a flow chart illustrating the functions which take place in the central computer 100 in response to an ALTER BOOK request from a subscriber.

In Figure 4.7, the appropriate programme is entered into the core memory at 490 and initialised. Decisions 492, 494 and 496 check the status of the system, the physical subscriber and the logical subscriber respectively. The input message is validated at 498 and checked for errors at decision 500. The stock record is read into the core memory at 502 and checked for errors by decision 504.

Next, at 506, the entry to be changed is located in the stock record and checked for errors by decision 508.

Assuming that there are no errors and that all statuses are correct, the programme proceeds to point A, still in Figure 7.1, at which the price format and currency are checked and modified as necessary at 510, the modification being just for internal dealings within the computer, there is then a check as to whether there are any errors in the price format and currency at 512, then the consideration is checked at 514 to ensure it is within system limits. At 516 the price qualifier of the existing entry is checked against the input message and updated if necessary, an error check is made at 518, then the expiry time is checked and updated if necessary at 520 and a further error check made at 522.

After all the data in the stock entry has been checked, the programme proceeds to point B on Figure 7.2 and the actual stock record is updated at 524. At 526, an off-line report is built, a message is sent to the physical subscriber who is using the ALTER BOOK facility at 528, at 530 a message is sent to the monitor and to the log records stored on disc 110, at 532 a decision as to whether the revision is to be broadcast is taken, and if so the broadcast message is built and sent at 534. Then the stock record is updated at 536 and the programme exits at 538.

If any of decisions 492, 494 and 496 result in a NO indicating that the relevant status is inappropriate, or if errors are detected at decision 500 or 504, the programme moves to point Z on Figure 7.2 and the error handler programme is called at 540, and the programme exited at 538 thereafter. If any of decisions 508, 512, 514, 518 and 522 result in detection of an error, the programme moves to point Y in Figure 7.2 and the stock record is released at 542 before the error handler is called at 540. The ALTER BOOK facility may also be used to withdraw an entry.

The data sent to the monitor and to the disc storage unit 110 when the ALTER BOOK facility is used, is as follows:

(a) The time at which the request was processed;

(b) The word "REVISN", being an abbreviation of "revision", the words "LTD" or "BCST" as appropriate, being abbreviations for "limited" meaning discreet and "broadcast" respectively;

(c) The entry number;

(d) The stock code;

(e) BUY/SELL indication;

(f) Quantity;

(g) Stock name;

(h) Price;

(i) Price qualifier;

(j) Expiry time.

#### Contact

As a result of the use of any of the foregoing facilities which have been described in detail with reference to the flow charts, any one subscriber may wish to get into contact with another. As has been explained, the system is arranged so that contact between subscribers is anonymous, and accordingly such contact is made by way of a "contact number" which is allotted by the system and which is unique to any particular entry in the book and to the pair of subscribers who may contact each other in connection with the entry. If a subscriber wishes to make contact as a result of entries located in a search, he will already be aware of the contact number for that particular entry. Also if the central computer notifies a subscriber that one of his existing entries is being searched a contact number will automatically be allotted and will accompany the notification. If, however, the entry in question has come to the notice of a subscriber as a result of another subscriber making a broadcast entry, it is necessary for the subscriber wishing to

make contact to obtain a contact number. This is done by depressing key 192, to call up the appropriate proforma.

The following Table 14 illustrates an example of use of the contact facility:

TABLE 14

<u>CONTACT</u>	<u>ENTRY</u>	<u>STOCK</u>
	331	ICI

11.15 SYSTEM USE CONTACT NUMBER 2046 TO ADDRESS ENTRY 331/ICI

5 As can be seen the proforma consists of the title CONTACT and two fields for information headed respectively ENTRY and STOCK in which the subscriber must key in the number of the entry he is interested in and the stock code. The system responds by displaying first of all the time at which the facility is requested, then the message "SYSTEM USE CONTACT NUMBER (then the number is given) TO ADDRESS ENTRY (then the entry number and stock code are given)". As can be seen in the above example of Table 14, the subscriber is interested in entry number 331 on the ICI book and he is instructed to use contact number 2046 to address the subscriber who made that entry.

10

15 Figure 8 is a flow chart illustrating the operations which take place in the central computer 100 when the contact facility is used. The appropriate program is entered into the core memory at 550 and initialised at 552. Then, decision 554 checks that the system is logged on, that is to say in an operating condition; decision 556 checks that the physical subscriber is valid (the physical subscriber may be the monitor as explained acting on behalf of an actual subscriber, referred to as the logical subscriber); decision 558 checks that the logical subscriber is valid; decision 560 checks that the message sent to the central computer is valid; decisions 562 and 564 respectively check the validity of the subscriber and stock records; decision 556 determines whether the stock is a training stock or a real stock; and, in the case of a real stock, decision 568 checks whether the system is signed on i.e. open for business since, real stocks may only be dealt with while the system is signed on for business, but training stocks may be dealt with at any time provided of course the system is logged on (i.e. operative). After decision 556, the program proceeds to point A directly if the stock is a training stock then it proceeds to decision 568 and then on to point A if the stock is a real stock and the system is signed on. If any of decisions 554, 556, 558, 560, 562, 564 and 568 result in a NO, the program proceeds to point B, following which the error handler is called at 570 and the program exited at 572.

20

25 If the program proceeds to point A, the validity of the stock entry and entry originator are checked respectively at decisions 574 and 576 and the validity of the conversation record is checked at 578 in order to determine that it is not at present in use for another contact, which would be an error condition.

30

35 If any of decisions 574, 576 and 578 result in a NO, the program proceeds to stage 570 at which the error handler is called, but if these decisions all result in a YES, the program proceeds to point C in Figure 8.2. In Figure 8.2, the conversation record is first updated at stage 580, that is to say the next available contact number (it will be recalled that contact numbers are allotted in sequence) is associated with the entry in question and the identity of the two subscribers who will be able to contact each other using this number is also associated with the conversation number and the entry. Thus, at this stage the unique contact number to be used exclusively by a particular pair of subscribers in connection with a particular entry is established.

40

45 Next, at 582, an off-line report concerning the contact facility is set up, at 584 a message is sent to the subscriber advising him of the contact number to be used in connection with the entry in question (see Table 4), at 586 a message is built and sent to the subscriber who originated the entry in question, for the purpose of advising the enterer of the contact member. The enterer receives the contact number in the bottom area 144 of his screen; and at 588, a message is built and sent

50

to the monitor station. At 590, the updated conversation record is written in disc storage unit 108 and at 592, the program is exited from the core memory 104.

The message which is sent to the monitor and to the log storage unit 110 at stage 588 includes the following:

- 5 (a) The time at which the contact number was requested; 5
- (b) The monitor slip number;
- (c) The reference number of the logical subscriber who originated the contact facility;
- 10 (d) The literal CTCT, being an abbreviation of the word CONTACT; 10
- (e) The contact number allocated;
- (f) The reference number of the subscriber who originated the entry;
- (g) The entry number.

#### Offer/Bid

15 When the subscriber has obtained the contact number he may then negotiate 15  
with the other subscriber concerning the entry in question. In order to do this, he  
uses the offer/bid facility. At this point it may be emphasised that use of the EN-  
TER BOOK facility does not of itself result in the subscriber making an offer to sell  
or bid to buy which is binding on the subscriber making the entry. For this reason,  
20 entries in the book have been referred to herein merely as "expressions of interest" 20  
in buying or selling particular stock. However, when the OFFER/BID facility is  
used, offers to sell and bids to buy are binding, for the specified time limit, on the  
subscriber making the bid or offer.

25 Thus, a subscriber wishing to make a binding bid or offer must first depress his 25  
key 194 to call up the appropriate proforma into area 140 of his screen. The  
following Table 15 is an example:

TABLE 15

OFFER/BID	CONTACT	B/S	QUANTITY	PRICE	xdr	expiry
	2375	SELL	58600	289		+20

message

---

14.12 2375/1 OFFER SENT 58,600 IMPERIAL CHEMICAL @ 289 14.32

30 As can be seen, the proforma consists of the title OFFER/BID then a field 30  
headed CONTACT for inserting the contact number, a field headed B/S for  
indicating whether the subscriber using the facility wishes to buy or to sell shares, a  
field for the QUANTITY, a field for the PRICE, a field headed xdr which, as  
usual, is for price qualifier and a field headed expiry for indicating the expiry time  
of the binding offer or bid to be made. Thus in Table 15 the contact number to be  
used is 2375 and the offer is to sell 58,600 of the shares in question (it may be noted  
35 that at this stage the stock code does not have to be used) at a price of 289. In 35  
addition to the data fields, the word "message" appears in line position number 3 on  
the screen and this is to enable the subscriber to accompany his offer by a message,  
such as "NO NEGOTIATION" indicating that he is not prepared to depart in any  
way from the offer given.

40 As previously, if there are no price qualifiers then the subscriber does not 40  
enter any data into the relevant field. The system has limits built in as to the  
possible expiry time and these must be entered in minutes. The expiry time may be  
from 2 to 60 minutes, but of course the system may be varied to allow other expiry  
times if desired. Also, preferably the system has an automatically allotted expiry  
time in the event that the field headed "expiry" is not completed by the subscriber,  
45 preferably the automatic expiry time would be 5 minutes. It will be noted from 45  
Table 15 that the expiry time given is +20 indicating that the offer is good for 20  
minutes.

Having entered the relevant data and message, if any, the subscriber presses his transmit key and the message is transmitted to the central computer and the response is confirmed in area 142 of the subscriber's screen. As usual, the message begins with the current time, then follows the contact number which in this case is followed by an oblique (/) which in turn is followed by the number 1 which indicates that this is the first message in the negotiation. Then there are details of the offer and finally the time at which the offer will expire, which of course in this example, since the time indicated for the sending of the message is 14.12, the expiry time will be 14.12 plus 20 namely 14.32. Of course, the message displayed in area 142 is only displayed after the central computer has transmitted the message on to the subscriber to whom it is addressed.

The words "OFFER SENT" in the message sent indicate that it is an offer to sell which is being made; if it was a bid to buy, then the words "OFFER SENT" would be replaced by "BID SENT".

The subscriber to whom the offer is addressed receives the message in the following form:

TABLE 16

14.12 2375/1 OFFER RCVD 58,600 IMPERIAL CHEMICAL @ 289 14.32

As can be seen the subscriber addressed is given the contact number followed by the oblique stroke and a number indicating the number of the message in this particular negotiation or conversation (namely 1), this is followed by the words "OFFER RCVD" which is an abbreviation of "offer received" indicating that it is an offer to sell, and then follows the actual details of the sell offer and the time of expiry. The subscriber who has received the offer may then if he wishes send a counter offer to the first subscriber who in turn may send a message or counter offer back to the second subscriber. Each message or offer will be identified by the contact number followed by an oblique stroke and the number of the message or offer. The following Table 17 will illustrate the information appearing on the first subscriber's screen when, in this example, a total of three messages have been sent:

TABLE 17

<u>OFFER/BID</u>	<u>CONTACT</u>	<u>B/S</u>	<u>QUANTITY</u>	<u>PRICE</u>	<u>xdrc</u>	<u>expiry</u>
message	2375/3	SELL	58600	288		+5
NO NEGOTIATION						

14.12 2375/1 OFFER SENT 58,600 IMPERIAL CHEMICAL @ 289 14.32

14.15 2375/2 BID RCVD 58,600 IMPERIAL CHEMICAL @ 286 14.20

14.18 2375/3 OFFER SENT 58,600 IMPERIAL CHEMICAL @ 288 14.23

NO NEGOTIATION

If it is assumed that the subscriber initiating the conversation is subscriber A, and the subscriber and the other party to the conversation is subscriber B, the sequence of events which have taken place as shown by Table 17, which is the display on subscriber A's screen is as follows

First, at 14.12, subscriber A offered to sell to subscriber B 58,600 ICI shares at 289, this offer being set to expire at 14.32. At 14.15, subscriber B also using the OFFER/BID facility countered this offer with a bid to purchase the 58,600 Imperial Chemical Industries shares at a price of 286 and indicated that his bid was good for 5 minutes i.e. it was to expire at 14.20. This bid was the second message in the conversation and therefore is identified by 2375/2. In response to this, subscriber A was prepared to lower his price to 288 but was not prepared to negotiate any

further. He therefore sent the appropriate message at 14.18 and he set an expiry time of 5 minutes namely 14.23 on this. This response by subscriber A supersedes his previous offer automatically in the system, and the system stores, in the conversation record, details of the latest two messages in the conversation, namely the messages identified by numbers 2375/1 and 2375/2 are stored until such time as 2375/3 is sent and at that point 2375/1 is deleted and only 2375/2 and 2375/3 remain in the store.

The data appearing on subscriber B's screen is as follows:

TABLE 18

OFFER/BID	CONTACT	B/S	QUANTITY	PRICE	xdrc	expiry
	2375/2	BUY	58600	286	.	+5

message

14.12	2375/1	<u>OFFER RCVD</u>	58,600	IMPERIAL CHEMICAL @ 289	14.12
14.15	2375/2	<u>BID SENT</u>	58,600	IMPERIAL CHEMICAL @ 286	14.20
14.18	2375/3	<u>OFFER RCVD</u>	58,600	IMPERIAL CHEMICAL @ 288	14.23

NO NEGOTIATION

It will be assumed in this case that the negotiations do not result in a bargain being struck and thus the subscribers will simply cease sending offers or bids to each other.

Figure 9 is a flow chart illustrating the functions which take place in the central computer 100 when an offer or bid is made. The appropriate program is entered into the core memory at 600 and initialised at 602. Decision 604 determines whether the system is logged on and decisions 606 and 608 determine respectively whether the physical and logical subscriber are valid. Decisions 610 and 612 determine respectively whether the start and end of the message are valid. Decision 614 determines whether the contact record is compatible, that is to say the contact number and the subscriber making use of the OFFER/BID facility are checked, for compatibility, with the conversation record which contains details of the contact numbers and the subscribers unique to the given contact number. Thus, if a subscriber enters a contact number which has not been assigned to him, incompatibility will be indicated.

Assuming the decisions so far described with reference to Figure 9 all result in a YES, the program proceeds to point A and decision 616 determines whether the second party to the contact (i.e. the one who is to be contacted) is valid. Assuming validity is found, the contact record is updated at 618. In the case of the first or second message in the negotiation, this involves recording that message; in the case of subsequent messages, it involves deleting the older of the two messages already recorded, on the appropriate side i.e. buy or sell, and recording the latest message, so that the latest bid and latest offer are always in the record. Of the two, only the very latest can be accepted; that is to say if a prospective seller offers shares at a particular price and in response the prospective buyer makes a bid at a lower price, the buyer cannot thereafter accept the offer at the higher price even though the seller may not accept the bid at the lower price.

At 620 an off-line report about the conversation is prepared and sent to storage unit 110. At 622, the confirmation message is built and sent back to the subscriber using the facility and at 624 a message is built and sent to the subscriber being addressed. At 628 the message is built and sent to the monitor station. At 630 the contact record updated at 618 is written into storage unit 100 and the program exits at 632.

In the event of any of the decisions described with reference to Figure 9 resulting in a NO, the program moves to point B and the contact record is released at 634, if it has already been read into the core memory, and the error handler called at 636, this being followed by exiting of the program at 638.

As has been indicated, when a subscriber is using the offer/bid facility, he can also include with his offer/bid a message to the other subscriber. The message can be in any form that the subscriber sending it wishes. One example given has been "NO NEGOTIATION" indicating that the subscriber is not prepared to consider any counter offers. Another form of message which a subscriber might use would be, in cases where he wishes to make a firm offer to buy or sell only a certain quantity of stock at a certain price, but wishes to indicate to the other subscriber that he would be prepared to consider selling more or less would be to put into the message space on the screen the words "COULD DO MORE" or "WOULD BE PREPARED TO DO LESS", for example. It has been explained that area 140 of the screen of each subscriber terminal consists of four lines of the screen (the fifth line being taken up by the broken line dividing areas 140 and 142), and thus when sending a message along with a binding bid or offer, since the proforma is in line position 1, and the data has to be in line position 2, there remains one line, namely line position 3, for the insertion of the message, line 4 being for the display of error messages from the computer 100. Subscribers other than the two involved in the negotiations are not informed of the negotiations taking place.

#### Message

Once a subscriber has obtained a contact number for contacting a particular subscriber it is possible for him to send a message to that subscriber using the MESSAGE facility, without making a binding offer to buy or sell shares. It may be stated again at this point that use of the offer/bid facility involves making a binding offer to the other subscriber and thus, once the other subscriber has accepted an offer made via the offer/bid facility, the first subscriber cannot change his mind. It might also be emphasized at this point that when a subscriber puts an entry on a particular book using the ENTER BOOK facility, this is not a binding offer: it is merely an expression that he would be interested in dealing in the specified amount of stock at the specified price, and it is up to other subscribers finding that entry or noting it if it is broadcast, to use it as a starting point for negotiation.

The system is preferably set up so that once a contact number has been assigned to a given combination of subscribers and entry, it will remain good for a predetermined period, preferably the remainder of the day of business in which the contact number is established by the system. Thus, in the preferred embodiment, once a contact number has been assigned it can be used for the rest of that day of business for the two subscribers to whom it is unique to send offers, bids and messages to each other anonymously. To make use of the MESSAGE facility, the subscriber depresses key 198 on his keyboard and this calls up the appropriate proforma on to area 140 of his screen.

The following Table 19 illustrates an example of the MESSAGE facility:

TABLE 19

#### MESSAGE CONTACT

2046

MESSAGE I HAVE 10,000 MORE

---

11.20 2046 MSG SENT IMPERIAL CHEMICAL  
I HAVE 10,000 MORE

As can be seen from Table 19, the proforma for the MESSAGE facility begins with the title of the facility and is followed by the heading "CONTACT" which indicates the only data field which is employed in this facility. In this data field, the subscriber keys in the contact number in question and, in the next line, which begins with the word MESSAGE, he keys in his message. As with the offer/bid facility, there is one line available for the message. In the example in Table 19 the message is simply "I HAVE 10,000 MORE" and thus this example assumes that the



two subscribers have been negotiating over a particular stock, which negotiations may or may not have resulted in a bargain being struck, and the one subscriber is telling the other that he has 10,000 more, which, obviously, in this case he is prepared to consider selling.

5 Having keyed in his message, the subscriber depresses the transmit key on his terminal which sends the message to the central computer which, in turn, confirms the message has been sent by displaying a confirmation message, which is also printed, in area 142 of the screen of the subscriber using the facility. In this case, the confirmation message was sent at 11.20, then the contact number 2046 is given followed by the heading MSG SENT, with the actual message given underneath. 10 The reference to Imperial Chemical is given since, it will be recalled, the contact number is unique not only to the subscribers but to a particular entry in the book and in this case it is assumed that the book in question is for the stock of Imperial Chemical Industries.

15 The subscriber who has been addressed receives the following message on his screen, as indicated in Table 20;

TABLE 20

11.20 2046 MSG RCVD IMPERIAL CHEMICAL  
I HAVE 10,000 MORE

This is displayed in the central area 142.

20 As can be seen, in this case the message displayed on the subscribers screen indicates by the heading "MSG RCVD" that it is a received message from another subscriber. This message is accompanied by an audible alert on the receiving subscriber's terminal and is printed out.

25 Preferably also, the message facility can be used to send messages to the monitor room, for example to enable a subscriber to seek assistance from the controllers of the system, and in this case it is preferred that an appropriate word, such as "MONITOR" or a trade name for the system be employed for addressing the monitor station, in place of the use of a contact number.

30 It should be understood that the message facility can be used for sending any kind of message, not necessarily to do with the stock being negotiated, but it should further be emphasized that neither subscriber will know the identity of the other since the contact numbers will differ from day to day and only the monitor station staff controlling the system will have access to information as to what particular subscribers and entry are unique to a given contact number each day.

35 Figure 10 is a flow chart illustrating the operations which take place in the central computer when the message facility is used. The appropriate programme is entered at 640, the system status and message originator status i.e. the subscriber sending the message, are checked at decisions 642 and 644. Decision 646 checks the validity of the contents of the message. If any of these decisions indicate a NO, then the programme proceeds to the obtaining of the error handler at 648 and exit at 40 650. If the decisions all result in a YES, then the programme proceeds to subsequent processing steps indicated at 652.

The subsequent processing steps will depend upon who is sending the message and who it is addressed to. In particular, there are facilities for the following:

- 45 1. Message from subscriber to monitor station;
2. Message from monitor station to a subscriber;
3. Message from monitor station to all subscribers;
4. Message from monitor station to a selected group of subscribers;
5. Message from one subscriber to another subscriber.

50 In general, however, the subsequent processing steps will include entry of the appropriate program at 654. Then at 656 a decision is taken as to the status of the station or stations being addressed. If the status is in order, (the decision is YES), then an off-line report is set up at 658 and the appropriate messages are sent to the originating subscriber and to the addressed subscriber or subscribers, and also to the monitor station, at 660. The program will then exit at 662. If decision 656 revealed a NO, the program would have proceeded to point A, at which the error handler is called at 648. 55

It may be noted that when messages are sent using the message facility, no record is kept in the conversation records in storage unit 108.

However, the monitor station does receive data upon the use of this message facility, in particular the data received is as follows, it being in two lines on the screen of the monitor terminal:

- 5 (1) Line 1
- (a) Time at which the entry was made;
  - (b) Monitor slip number;
  - 10 (c) Originating subscriber reference number;
  - (d) Literal "MSG" being an abbreviation of the word message;
  - (e) Contact number;
  - (f) Receiving subscriber reference number;
  - (g) Stock name.
- 15 (2) Line 2  
The text of the message as put into the system. 15

#### Accept

20 If one subscriber makes a bid or offer that another subscriber wishes to accept, the bargain is consummated by the accepting subscriber making use of the ACCEPT facility. This is done by depressing key 196 to call up the appropriate proforma into area 140 of the terminal screen. The following Table 21 illustrates an example of acceptance: 20

TABLE 21

ACCEPTANCE    CONTACT/REF

2375            3

message

---

14.15 2375    ACCP SENT    58,600 IMPERIAL CHEMICAL @ 289

25 As can be seen the proforma as usual begins with the title, in this case "ACCEPTANCE", and it is followed by two fields headed respectively CONTACT and /REF. In the field headed CONTACT, the subscriber keys in the contact number used in the negotiations, and in the field headed /REF he keys in the latest received message (reply) number, in this case assumed to be message number 3. 25

30 In addition, he may key in a free format message if he wishes in the line position 3 of the screen, the word "MESSAGE" being displayed at the beginning of line position number 3 to indicate this to the subscriber. 30

35 The subscriber then, as usual, depresses his transmit key and this sends the appropriate acceptance message to the central computer which then sends the acceptance to the other subscriber. The confirmation message displayed on the first subscriber's screen is also shown in Table 29. As can be seen it begins with the time, then the contact number then the literal "ACCP SENT", being short for the phrase "acceptance sent", then details of the deal namely the amount of stock, the company and the price. 35

The subscriber whose offer or bid has been accepted receives notice of acceptance as indicated by the following table, in central area 142 of his screen;

TABLE 22

14.15 2375    ACCP RCVD    58,600 IMPERIAL CHEMICAL 289

Again the time, contact number and details of the bargain are given, together with the literal "ACCPY RCVD" being an abbreviation for "acceptance received".

The acceptance received message is also accompanied by an audible alert. Both the acceptance sent and acceptance received messages are automatically printed out on the respective subscriber terminals.

In addition, immediately following the acceptance sent and acceptance received messages, the central computer works out full details of the bargain which has been struck and displays it to the seller as follows:

**TABLE 23**

SYSTEM BARGAIN 19034	CONSIDERATION £169,354.00
IMPERIAL CHEMICAL	
SOLD 58,600 @ 289	
DEALT AT 14.15 ON 02/05/73	LESS FEE/VAT/C STAMP 559.47
FOR SETTLEMENT ON 22/05/73	PROVISIONAL NET PROCEEDS £168,794.53

As can be seen a bargain number is given for identification purposes, then the name of the company, then the total consideration for the bargain, all in the first line.

In the second line there is the indication that the stock has been sold by the subscriber in question then there is the amount of stock and the price per share.

In the next line there is the time and date of the deal, followed by the fee to be paid to the system owners and any taxes, such as Value Added Tax and stamp duties, all combined into a single figure.

Then in the last line there is a statement as to the date by which the debt must be settled, and then the net proceeds are given, which are equal to the consideration less the service fee and any taxes as referred to above.

The following Table 24 indicates the information concerning the deal displayed on the screen of the buyer, in area 142:

**TABLE 24**

SYSTEM BARGAIN 19034	CONSIDERATION £169,354.00
IMPERIAL CHEMICAL	
BOUGHT 58,600 @ 289	PLUS TRANSFER STAMP 1,694.00
DEALT AT 14.15 ON 02/05/73	PLUS FEE/VAT/C.STAMP 559.47
FOR SETTLEMENT ON 22/05/73	PROVISIONAL NET COST £171,607.47

It will be noted that this is basically similar to Table 23, but in this case the word "BOUGHT" is included instead of "SOLD" at the beginning of line 2, then there is the transfer stamp duty to be paid, followed by the system fee plus taxes etc., with a final total net cost, in this case the word "COST" being used to indicate that the buyer is indebted to the system by the specified amount whereas in Table 23 the word "PROCEEDS" is used indicating that the system operators are indebted to the seller by the amount given.

Tables 23 and 24 may be referred to as bargain confirmation notes.

If accrued interest is included in calculating the value of the bargain, then the bargain confirmation notes will be in accordance with the following Tables 25 and 26 for the seller and buyer respectively:

TABLE 25 SELLER

SYSTEM BARGAIN 19035	
LCC 6% 75—78	GROSS VALUE £420,000.00
SOLD 500,000 @ £84	PLUS 89 DAYS ACC INT 7,315.00
DEALT AT 14.30 ON 02/05/73	LESS FEE/VAT/C STAMP 46.80
FOR SETTLEMENT ON 03/05/73	PROVISIONAL NET PROCEEDS £427,268.20

TABLE 26 BUYER

SYSTEM BARGAIN 19035	
LCC 6% 75—78	GROSS VALUE £420,000.00
BOUGHT 500,000 @ £84	PLUS 89 DAYS ACC INT 7,315.00
DEALT AT 14.30 ON 02/05/73	PLUS FEE/VAT/STAMPS 46.80
FOR SETTLEMENT ON 03/05/73	PROVISIONAL NET COST £427,361.80

The subscriber who made the book entry which caused the bargain will also receive one of the following messages in connection with his entry. This message will be printed out automatically:

(1) NOW WITHDRAWN — FULLY DEALT

(2) HAS TIME EXPIRED (i.e. if expiry time associated with the entry has been passed)

(3) NOW WITHDRAWN — BALANCE BELOW SYSTEM MINIMUM

(4) NOW ADJUSTED TO (say) 10,000+ (i.e. if balance of entry remaining in the book has not time expired and is valued at more than the system minimum)

In the above example, therefore, the subscriber would have received the following message:

14.15 SYSTEM YOUR ENTRY 331/ICI NOW WITHDRAWN —  
BALANCE BELOW SYSTEM MINIMUM

In message (4) above, the balance entry remaining in the book retains the same details as were input in the original entry, apart from size of course.

Figure 11 is a flow chart illustrating the functions which take place in the central computer 100 when the acceptance facility is utilised. The appropriate programme is entered into the core memory at 650 and initialised at 652. Initial checking takes place at 654 and determination of whether there are any errors found in the initial checking is made at 656. Message validation takes place at 658 and a decision as to any errors revealed in message validation is taken at 660. Further validation takes place at 662 and determination of errors at 664. Assuming no errors are found, the traded entry is built at 666. The programme then proceeds to point A on Figure 11.2. Function 668, referring to "rump" entry, concerns the situation if an entry is partially traded. Thus at stage 668, if an entry is partially traded, the untraded part is built into a new entry to be re-inserted in the book if the total transaction of the new entry is still within system limits.

At 670, the conversation record is updated with details of the transaction and an off-line report is built at 672. At 674, the cumulative stock data used in the QUOTE facility is updated. At 676, the acceptance confirmation message is sent to the subscriber who has initiated the acceptance facility, and at 678 the acceptance received message is sent to the subscriber whose offer or bid has been accepted. Then the programme proceeds to point B in Figure 11.3.

At 680 in Figure 11.3, a message is sent to the monitor station, then at 682 the message concerning the entry which has been traded i.e. to indicate that it has been fully dealt or that the time has expired or only partially dealt etc. is sent to the subscriber who originated the entry. Then, at 684 the bargain confirmation notes (Tables 25 and 26) are sent to the appropriate subscribers and at 686 the stock records and conversation files are updated as necessary, and the programme exits at 688. If any errors were determined in the decisions in Figure 11.1, the programme proceeds to point Z, and the error handler is called at 690 and the stock and conversation files released at 692.

Although in the examples of the acceptance facility given, there were no price qualifiers concerned in the deals, these will of course be indicated in the acceptance sent confirmation or acceptance received messages displayed to the subscribers involved.

The data sent to the monitor station is as follows:

- (a) Time at which the function was used;
- (b) Monitor slip number;
- (c) The number of the subscriber using the acceptance facility;
- (d) The literal "ACCPY" being an abbreviation of the word "accept";
- (e) The contact number;
- (f) The number of the subscriber whose offer or bid has been accepted;
- (g) Quantity of stock involved;
- (h) Stock code;
- (i) Price per share;
- (j) Price qualifier.

In addition, if any free format message is included, this is displayed in the monitor station.

#### Copy of Broadcasts

The use of the general command proforma called up by the key 202 has already been discussed in connection with listing, signing on and signing off the system. Another use for this key is for instructing the system whether or not hard copy of messages is to be printed out by the subscriber's printer. If copy is required, under the heading "details" of the general command proforma already given, the word "COPY" is keyed in, in which case subsequently received broadcasts will be copied by the printer. Confirmation is indicated in area 142 of the screen by the message "SYSTEM BROADCAST COPY RESUMED" which is as usual preceded by the time. If the word NOCOPY is keyed in, and then the transmit key pressed, the system will cease printing out broadcasts and the message "SYSTEM BROADCAST COPY SUPPRESSED" will be displayed in area 142 again preceded by the time at which the facility was used.

#### Modifications

It is to be understood that a variety of modifications are possible within the scope of the invention as defined by the appended claims. For example, the data to be stored in the apparatus could be varied, although the preferred data to be stored has been described in the preferred embodiment. Although the preferred system has been described, in which a number of different functions are all available, the apparatus could be arranged so that not all of the described facilities are provided for. For example it would be possible to construct a system as herein described but in which there is no facility for the broadcasting of entries i.e. all entries would automatically be entered discreetly; or a system in which all entries would automatically be broadcast, or the search facility could be modified such that the range specified in Table 10 is 10% rather than 15%.

An example of an alternative or additional facility which may be employed will now be described.

#### Open Book

This facility will be regarded as an alternative to the QUOTE facility which has been described in detail hereinabove and therefore will be described as a modification of that facility. In the modification, live, traded and expired expressions of interest in a security will be displayed. QUOTE Part 1 will display the specific expressions of interest and QUOTE Part 2 will display current and previous months totals and details of the latest four trades.

To use QUOTE Part 1, the appropriate key is depressed to call up the QUOTE proforma. The following Table 27 illustrates an example:

TABLE 27

QUOTE	STOCK	part	copy?				
	HNDS	1	YES				
13.21	BUYERS	BOOK ON HNDS		HANDS HOLDINGS	SELLERS		P 1/2
437	25,000+	206 1/2 XD	15.00	441 100,000-	207 1/4		14.30
439	DISCREET	206	GTC	401 50,000	205		12/04 T
371	10,000+	204 1/2	13/04	X 389 15,000	204 XD		12/04 T
362	15,000	204 XD	12/04	T 276 25,000*	203 1/8		11/04 X

- 5 As can be seen, the proforma is as previously described in connection with the QUOTE facility. In this modification, if desired, completion of the field headed "part" may be optional, failure to complete the field being taken as an indication by the central computer that part 1 is required. 5
- 10 When QUOTE Part 1 is requested, the central computer retrieves the book for the stock in question, and live, expired and traded entries in the book are displayed, in the central area of the subscriber's screen. There will be a first column for the display of buyers and a second column for the display of sellers. The first line of the information displayed includes the time at which the request was processed, the title for the buyers column, stock code and stock name, the title for the sellers column, and the page number as usual. 10
- 15 The remaining lines (preferably there are five lines in all) consist of buy expressions of interest in the column headed "buy" and sell expressions of interest in the column headed "sell". Each expression of interest consists of: 15
- Entry number.
  - Quantity. Quantity is not shown for discreet entry, instead literal DISCREET displayed. No sign (+, - or \*) appears on traded entry. 20
  - Price qualifier.
  - Expiry time (HH.MM) for expiry on current day or expiry date (DD/MM) for expiry on previous day. GTC is displayed for a Good Till Cancelled entry. For a traded entry time (or date) of trade is shown.
  - Entry Status. Blank for live entry, X for expired entry or T for traded entry. 25
- Expressions of interest are displayed as follows:
- Live entries are listed in order of most favourable price i.e. highest BUY price and lowest SELL price displayed at top of list.
  - Expired and traded entries are listed in chronological order, most recent first. 30
  - If a particular subscriber has a live entry in the book as well as an expired and/or traded entry, then only the live entry of that subscriber will be displayed to the subscriber using the QUOTE Part 1 facility.
  - If a particular subscriber has both a traded entry and an expired entry, but no live entry, then only one of these will be displayed and this will be the most recently expired or traded entry. For entries from a previous date, but with the same date, then expired entries take priority over trades. 35
- 40 Accordingly, when a subscriber uses the QUOTE Part 1 facility he is now supplied with details of various entries and he may, using the CONTACT facility, obtain a contact number for sending messages or bids or offers to the subscribers who made the entries which have been displayed to him. 40
- In order that a subscriber using the QUOTE facility may make contact with either or both parties to a particular trade, the system is preferably arranged so that whenever a particular entry from one side of the book is traded, the same entry is

written into the opposite side of the book, as a traded entry, and with its own unique entry number. In this way, a traded entry may appear in both the "BUYERS" column and the "SELLERS" column (see Table 27) so that, using the entry number given under the BUYERS column a subscriber using the QUOTE facility can obtain a contact number for the buyer involved in that trade, and using the entry number given against the corresponding trade in the "SELLERS", the subscriber using the QUOTE facility may obtain a contact number for the seller involved in that trade. Thus, subscribers using the QUOTE Part 1 facility are enabled to make contact with the maximum possible number of other subscribers who might be interested in negotiations.

It will be recalled that when an entry is partially traded, the balance or "rump" remains in the book. Such entries are treated, in the OPEN BOOK facility under description, as live entries. Thus either the live part or the traded part of such an entry will be displayed in the QUOTE Part 1 facility, but whichever is displayed the same entry number will be used.

If no entries of any type are available for display then the following is displayed:

First Line — Time of Request

— Stock Code and Name

Second Line — Literal "NO ENTRIES IN BOOK"

The following Table 28 illustrates an example of QUOTE Part 2 in the OPEN BOOK facility:

TABLE 28

QUOTE	STOCK	part	copy?
	HNDS	2	YES

### 13.21 TRADING FIGURES AND LATEST BARGAINS FOR HANDS HOLDINGS

	DEALT APR	10,100,000	@ 198	—	203
	DEALT MAR	25,000,000	@ 202	—	204
12/04	15,000	@	204 XD	10/04	75,000 @ 203 1/2
09/04	25,000	@	201 3/4	09/04	14,000 @ 201 1/2

The book for the stock concerned is retrieved. The cumulative figures for trades for the current month to date and preceding month are extracted. Details of the latest traded entries (up to four) are extracted. The cumulative figures and details of the latest trades are displayed as follows:

First Line — Time of Request

— Stock Code and Stock Name

Second Line — Month mnemonic of current month

— Quantity of shares traded during the month to date

— Lowest price traded, month to date

— Highest price traded, month to date

Third Line — Month mnemonic of previous month

— Quantity of shares traded during previous month

— Lowest price traded during previous month

— Highest price traded during previous month

If there have been no trades during the relevant period then the quantity is omitted and the @ sign replaced with the literal "NONE".

In the third and fourth lines, the latest bargains (up to 4) are displayed, 2 trades per line, the most recent is to the left of the first line, the next to the right of the first line, and so on. Each trade displays the following information:

- Date of trade
- Quantity of shares traded
- Price and qualifier.

If there are no recent bargains then the literal "NO RECENT BARGAINS ON THIS STOCK" is displayed in line 3.

Other subscribers are not informed when one subscriber is using the OPEN BOOK facility.

When the OPEN BOOK facility is used, the following data is sent to the monitor station:

- Time of request
- Monitor slip number
- Logical subscriber reference number
- Literal "PRCE" if Part 1 of quote requested, else "TRAD" for Part 2, "HIST" for Part 3.
- Literal "C" if hard copy requested by the subscriber.
- Stock code of quoted stock.

It is considered unnecessary to illustrate a flow chart for the OPEN BOOK facility, since, it is believed, the logical steps which have to be executed in the computer to implement this facility will be apparent from the foregoing description.

The preferred embodiment of the invention has been described with reference mainly to the facilities available to the subscribers, and to the operations which take place in the computer when the facilities are used. Of course, additional facilities may be available to the monitor station, for example the monitor station may be able at any time to obtain full details of all entries in the books, including identities of subscribers and facilities may be included for enabling the monitor room to act on behalf of a subscriber if, for example, a particular subscriber finds that his terminal breaks down or if an experienced operator is unavailable for any reason at any subscriber station.

The electrical signals representing data and instructions transmitted to and from the central computer and subscriber stations for processing thereby may take any form conventional in the art, and thus, for the sake of brevity, such signals have not been described herein in detail. Similarly, address codes for ensuring that data is directed to the appropriate addresses in the apparatus, for example address codes for directing data to the appropriate part of the screen of the display units, can take any conventional form and these also have therefore not been described in detail.

Reference has already been made to our copending Application No. 34229/73 from which the present application is divided. Attention is also directed to our copending Application Nos 45305/74 and 45306/74 also divided from copending Application No. 34229/73 Serial Nos. 1 489 571, 1 489 573 and 1 489 574.

#### WHAT WE CLAIM IS:—

1. Apparatus operable to effect transactions in property, comprising a plurality of terminals, each including means for the input and output of data into and from the apparatus;

a data processor adapted to receive data from and transmit data to said terminals;

data storage means for recording data; and  
program means having instructions to cause said processor:

(a) to record in said storage means expressions of interest, received from the terminals, in buying and selling said property, said expressions of interest specifying a quantity of said property and a price therefor;

(b) to search said storage means, on command of a terminal transmitting to said processor data representing a requirement to deal in said property, for expressions of interest originated by other said terminals compatible with the requirement data, and to transmit only located compatible expressions of interest to the terminal commanding the search; and

(c) to record a transaction in said property in predetermined circumstances.

2. Apparatus according to claim 1, arranged to specify, by data input at a terminal, a range of quantity for said property in said expressions of interest.

3. Apparatus according to claim 2, arranged so that said range is specified by a figure and an indication of whether the expression of interest is in dealing in said property in quantities greater than or less than said specified figure.

4. Apparatus according to claim 1, 2 or 3, arranged to specify by data input at a



terminal an exact quantity of said property in said expressions of interest.

5. Apparatus according to any preceding claim arranged to specify by data input at a terminal an expiry time for an expression of interest originated at said terminal.

6. Apparatus according to any preceding claim, arranged to specify by data input at a terminal that an expression of interest originated by said terminal should remain good until cancelled by said terminal.

7. Apparatus according to any of claims 1 to 4, wherein the program means includes instructions to cause the processor to designate expiry of an expression of interest automatically at a predetermined time.

8. Apparatus according to claims 5 and 6, wherein the program means includes instructions to cause the processor to designate expiry of an expression of interest automatically at a predetermined time, in the event that the terminal from which the expression of interest originated does not provide data specifying an expiry time or that the expression of interest should remain good until cancelled.

9. Apparatus according to any preceding claim, wherein the program means include instructions to cause the processor to alter or withdraw an expression of interest recorded in said storage means, on command of the terminal from which the expression of interest was originated.

10. Apparatus according to any of claims 1 to 4, or any of claims 5 to 9, as dependent thereon, wherein the program means includes instructions to cause the processor to prevent, on command of a terminal originating an expression of interest, the quantity specified in the expression of interest being transmitted to other said terminals.

11. Apparatus according to any preceding claim, wherein said program means includes instructions to cause said processor to broadcast said received expression of interest to a plurality of said other terminals.

12. Apparatus according to claim 11, wherein said program means includes instructions to cause the processor to cause said broadcast to take place only on command of the terminal from which the expressions of interest originates.

13. Apparatus according to any preceding claim, wherein the program means includes instructions to cause said processor for automatically to transact a new expression of interest with a previously recorded expression of interest if said expressions of interest are mutually compatible.

14. Apparatus according to any preceding claim, arranged so that said requirement data includes a specified quantity of said property.

15. Apparatus according to claim 14, arranged so that the requirement data may include a range of quantity of said property.

16. Apparatus according to claim 15, wherein said range of quantity of property in said requirement data is specified by a number and an indication that the requirement is to deal in quantities greater or less than said number.

17. Apparatus according to claim 14, 15, or 16, arranged so that an exact quantity may be specified in said requirement data.

18. Apparatus according to any preceding claim, arranged so that said requirement data includes price of said property.

19. Apparatus according to any of claims 13 to 18, as dependent upon claim 12, wherein said program means includes instructions to cause said processor to inhibit the transmission to said terminal commanding said search of the quantity specified in any located expressions of interest which were not broadcast.

20. Apparatus according to any preceding claim, wherein said program means includes instructions to cause said processor to inform a terminal which has originated an expression of interest whenever that expression of interest is transmitted to a said terminal commanding a said search.

21. Apparatus according to claim 20, wherein said program means includes instructions to cause said processor to inform said originating terminal of the requirement data specified by said terminal commanding said search.

22. Apparatus according to claim 21, wherein said program means includes instructions to cause said processor to inhibit, on command of said terminal commanding said search, the transmission to the originating terminal of the quantity specified in said requirement data.

23. Apparatus according to claim 19 or any of claims 20 to 22 as dependent thereon, wherein said terminal commanding said search receives, instead of the quantity specified in any compatible expressions of interest which was not broadcast, an indication of whether the quantity of the said expressions of interest is greater or less than the quantity of the requirement data.

24. Apparatus according to claim 22 or claim 23, as dependent thereon,

wherein the originating terminal receives, instead of the quantity specified in the requirement data, an indication of whether said quantity is more or less than the quantity specified in the expression of interest.

- 5 25. Apparatus according to claims 4 and 17 or any claim dependent thereon, wherein said program means includes instructions to cause said processor to treat any expression of interest specifying an exact quantity as compatible with requirement data specifying an exact quantity if the quantity specified in the expression of interest is within a predetermined range of the quantity specified in the requirement data. 5
- 10 26. Apparatus according to claim 25, wherein said predetermined range is the quantity specified in the requirement data plus or minus a predetermined percentage thereof, said percentage being not more than 15%. 10
27. Apparatus according to claim 26, wherein the percentage is 15%.
28. Apparatus according to claim 26, wherein the percentage is 10%.
- 15 29. Apparatus according to claim 12 and any of claims 25 to 28, wherein the program means includes instructions such that, if a non-broadcast expression of interest specifying a precise quantity is located in a said search, the terminal commanding the search will be informed of said expression of interest only if the quantity specified in the expression of interest and the quantity specified in the request data are equal, but nevertheless the terminal which originated the expression of interest will be informed that said expression of interest has been located in said search. 15
- 20 30. Apparatus according to any preceding claim, wherein said terminals are arranged as a plurality of groups, and arranged such that said requirement data may include a group designation, said program means including instructions to cause said processor to exclude in response to a said group designation, expressions of interest originated by terminals of said designated group from the expressions of interest transmitted to the commanding terminal. 20
- 25 31. Apparatus according to any of claims 1 to 29, wherein said terminals are arranged as a plurality of groups, or according to claim 30, and wherein said program means includes instructions to cause said processor to inhibit the transmission of an expression of interest to designated groups on command of the terminal originating the expression of interest. 25
- 30 32. Apparatus according to any preceding claim, wherein said program means includes instructions to cause said processor to provide a code for use by terminals in exchanging messages so that said messages may be exchanged without either terminal knowing the identity of the other. 30
- 35 33. Apparatus according to claim 32, wherein said code is assigned automatically when an expression of interest is located in a said search and transmitted to the terminal commanding the search and/or the terminal originating the expression of interest, as the case may be, along with any other data transmitted thereto as a result of said search. 35
- 40 34. Apparatus according to claim 32 or 33, as dependent directly or indirectly upon claim 11 or 12, wherein said program means includes instructions to cause said processor to assign, on command of a terminal receiving a said broadcast expression of interest, a said code to enable said receiving terminal to send a said message to the terminal originating the broadcast expression of interest. 40
- 45 35. Apparatus according to any of claims 32 to 34, wherein said program means includes instructions to cause said processor to maintain an assigned code valid until a predetermined time and thereafter to render it invalid. 45
- 50 36. Apparatus according to any preceding claim, wherein said program means includes instructions to cause said processor to locate on request of any of said terminals, expressions of interest in said storage means originated by said requesting terminal and to transmit said expressions of interest to said requesting terminal. 50
- 55 37. Apparatus according to any preceding claim, wherein said program means includes instructions to cause said processor to transmit details of each recorded transaction to the terminals party to said transaction to confirm to said terminals that the transaction has been effected. 55
- 60 38. Apparatus according to any preceding claim, wherein each said terminal includes a visual display unit having a screen divided into a plurality of different areas, and wherein different types of data to be displayed on said screen are addressed to different areas thereof. 60
- 65 39. Apparatus according to claim 38, wherein each said screen includes a first area in which data input into the apparatus via the associated terminal for com- 65

manding said apparatus is displayed, and a further area in which messages received on command of the processor or another terminal are displayed.

40. Apparatus according to claims 38 and 39, including means to display in the first area of the screen proformas indicating different data to be input to command the apparatus to perform respective different functions.

41. Apparatus according to claim 39 or 40, wherein the further area of the screen includes a first section in which messages indicating that said processor has acted on said command are displayed and in which messages received on command of another terminal are displayed.

42. Apparatus according to claim 41, as dependent upon claim 37, wherein said data representing a transaction which has been effected is displayed in said first section of said further area of said screen.

43. Apparatus according to claim 41 or 42 as dependent directly or indirectly upon claim 11 or 12, wherein broadcast expressions of interest originated by other terminals are displayed in a second section of said further area.

44. Apparatus according to claim 43, and according to claim 20, 21, 22 or 24, wherein messages to a terminal indicating that expressions of interest originated by that terminal have been located in a said search are displayed in said second section of said further area.

45. Apparatus according to any of claims 41 to 44, wherein said first and second sections of said further area are a variable size relative to each other, the size of said further area remaining constant.

46. Apparatus according to claim 45, wherein the size of said first section is automatically increased as necessary up to a maximum, at the expense of said second section, when data is added to said first section.

47. Apparatus according to any of claims 38 to 46, wherein error messages indicating that input data is in error are displayed in the first area of said screen.

48. Apparatus according to any preceding claim, wherein said program means includes instructions to cause the processor to quote on command of a terminal a summary of data indicative of transactions executed on said apparatus within a predetermined past time period.

49. Apparatus according to claim 48, wherein said summary of data includes the current range of buyers' and sellers' prices as expressed in expressions of interest and the aggregate volume and price range of transactions effected during a predetermined time period and/or the quantity and price of each of a number of the latest transactions executed on the apparatus.

50. Apparatus according to claim 5, 7 or 8 and according to claim 48 or 49, wherein the summary of data includes unexpired, transacted and expired expressions of interest.

51. Apparatus according to claim 50, wherein said program means includes instructions effective to cause said processor when a transaction is effected in relation to a buy expression of interest or a sell expression of interest, to create and record in said storage means a pseudo sell expression of interest or a pseudo buy expression of interest respectively, and said summary of data includes both the transacted expression of interest and the pseudo expression of interest corresponding thereto, to enable the terminal requesting said summary of data to make contact with either terminal involved in said transaction.

52. Apparatus according to any of claims 49 to 51, wherein the program means includes instructions such that, in the event that there are a plurality of expressions of interest recorded in said storage means, whether unexpired, expired or transacted, originated from the same terminal, only one of said expressions of interest is included in said summary of data.

53. Apparatus according to claim 52, wherein an unexpired expression of interest of a said same terminal takes precedence for inclusion in said summary of data over a traded expression of interest or an expired expression of interest, and in the event of there being no unexpired expressions of interest, the most recent of the transacted and expired expressions of interest takes precedence for inclusion in said summary of data.

54. Apparatus according to any preceding claim, wherein said property is securities.

55. Apparatus according to claim 52, arranged to effect transactions in a plurality of different securities, and arranged so that each expression of interest and each requirement data specifies the security to which it relates.

56. Apparatus according to any preceding claim including means to generate

an alert at each terminal when predetermined data is transmitted thereto from the data processor.

5 57. Apparatus according to claim 56 wherein a said alert is generated at a terminal when being informed that an expression of interest originated thereby has been located in a said search. 5

R. G. C. JENKINS & CO.,  
Chartered Patent Agents,  
Chancery House,  
53/64 Chancery Lane,  
London, WC2A 1QU.  
Agents for the Applicants.

---

Printed for Her Majesty's Stationery Office by the Courier Press, Leamington Spa, 1977.  
Published by the Patent Office, 25 Southampton Buildings, London, WC2A 1AY, from  
which copies may be obtained.

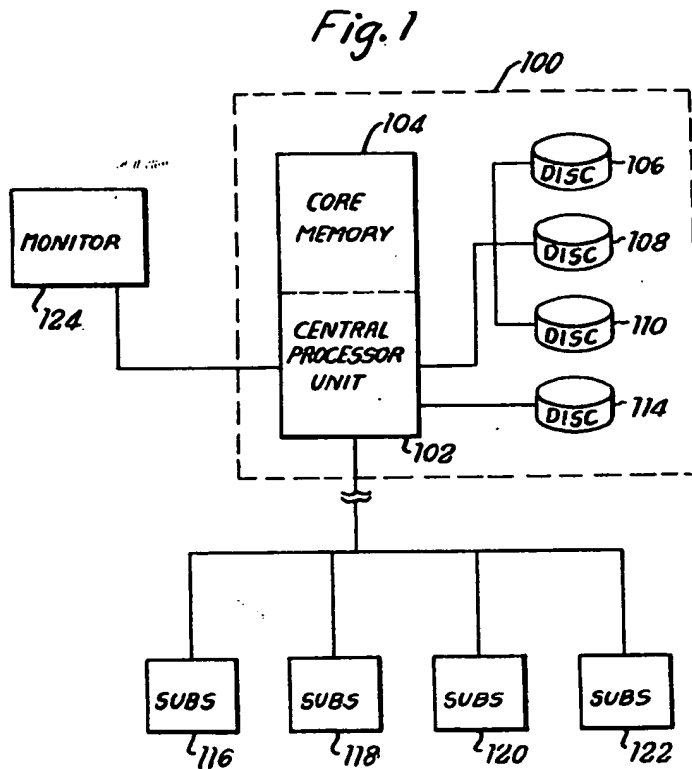
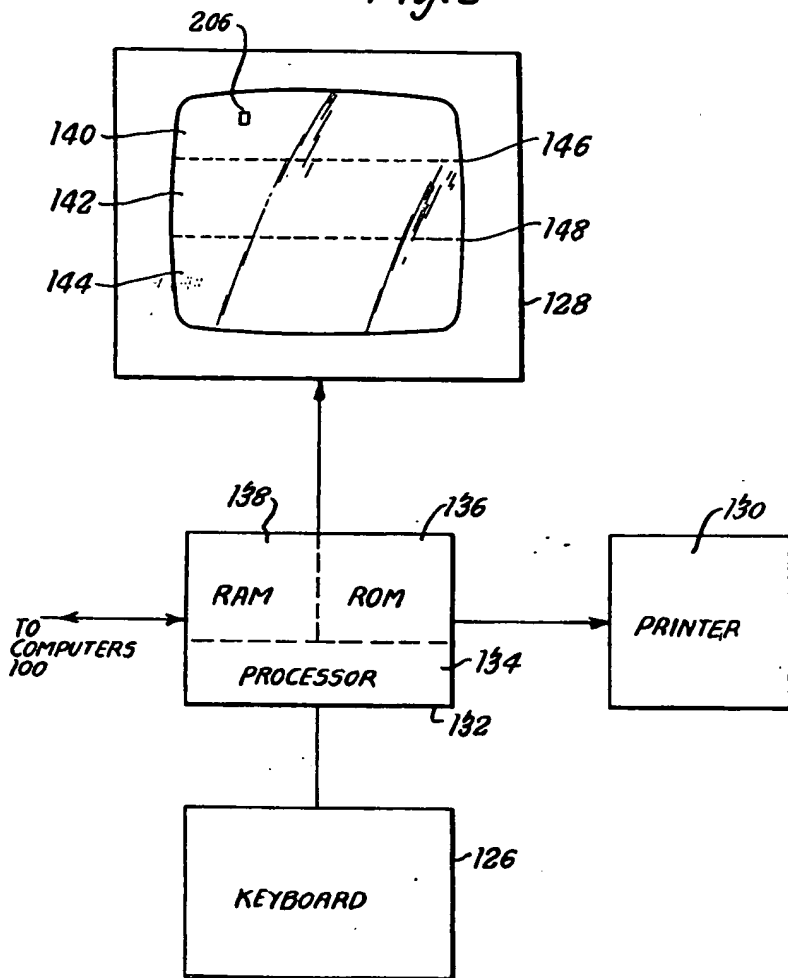

Fig. 2



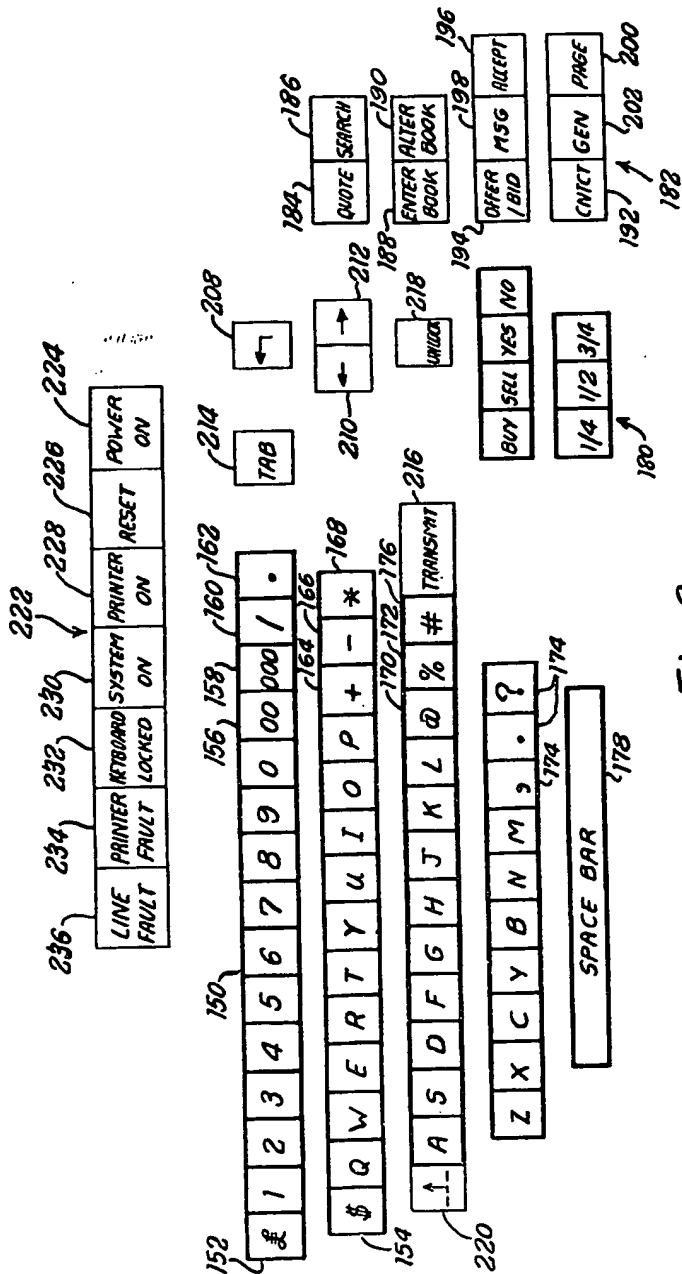

Fig. 3

Fig. 4.1

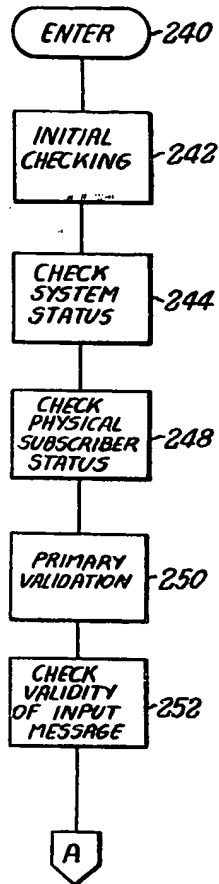

Fig. 4.2

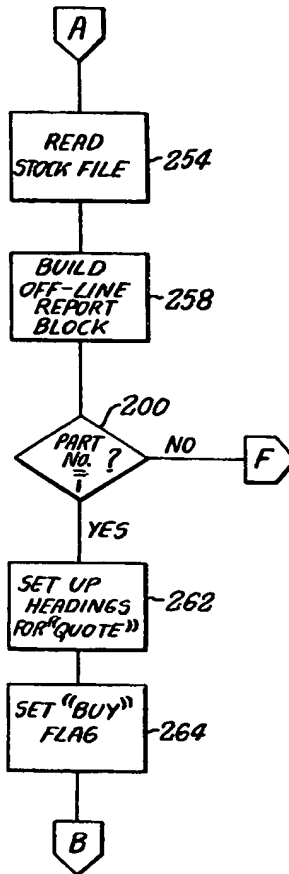



Fig. 4.3

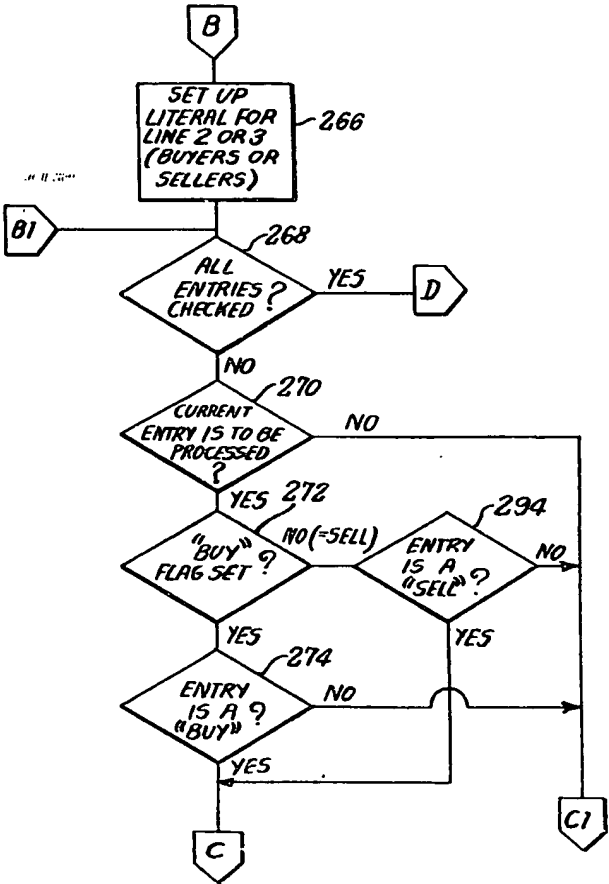

Fig. 4.4

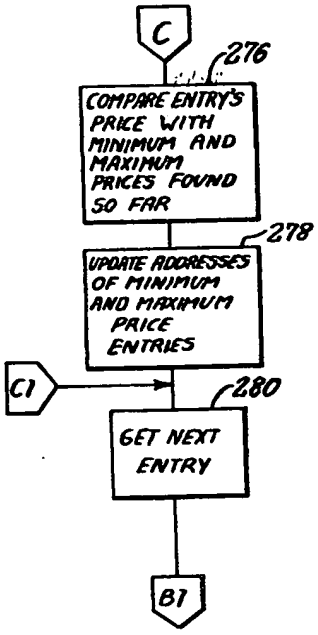

Fig. 4.5

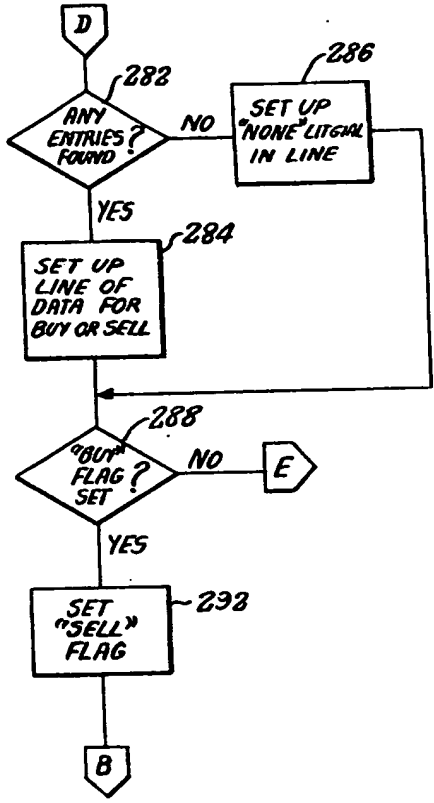
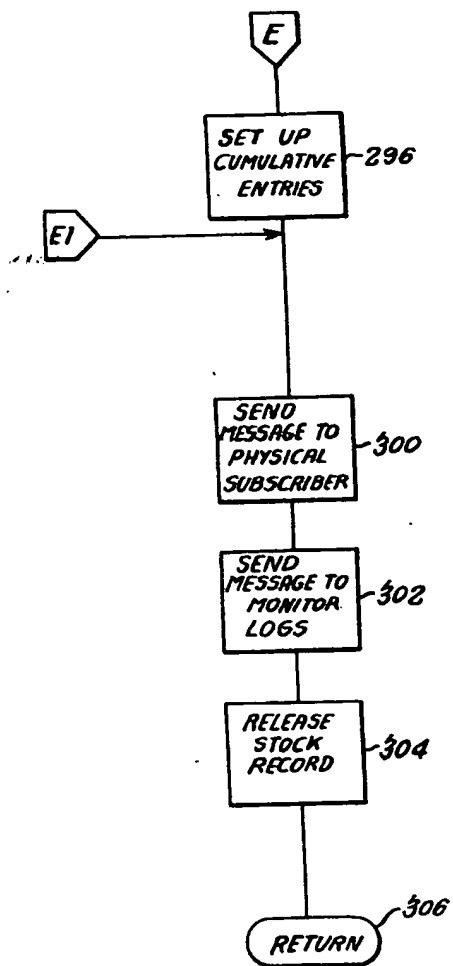

Fig.4.6



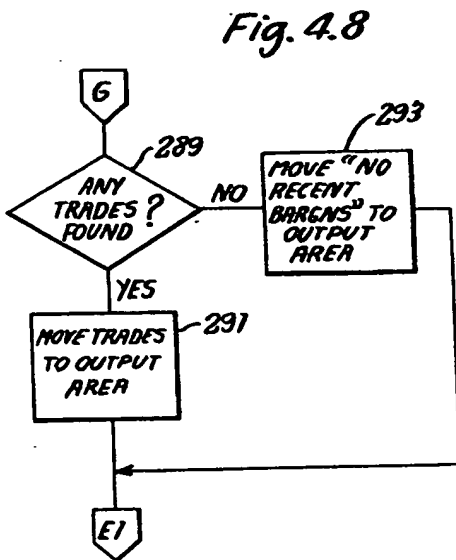
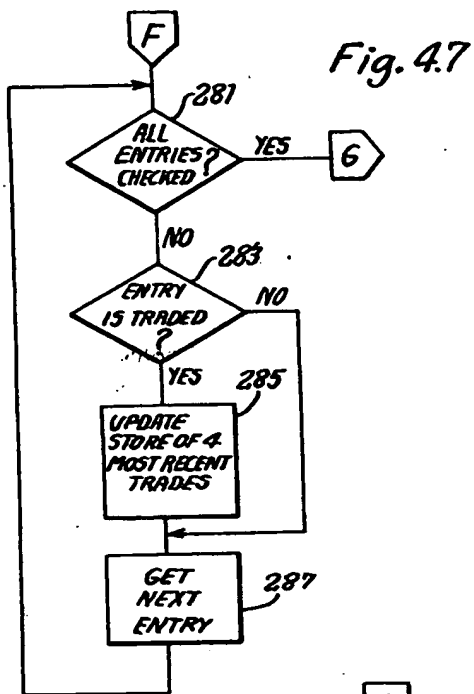

Fig. 5.1

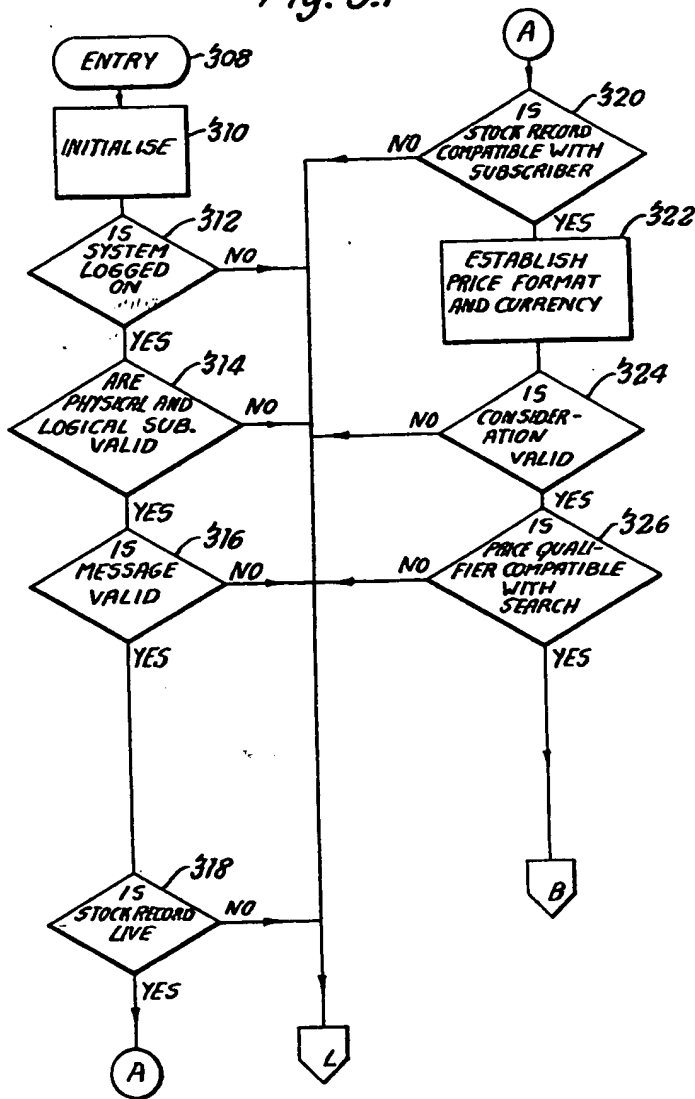
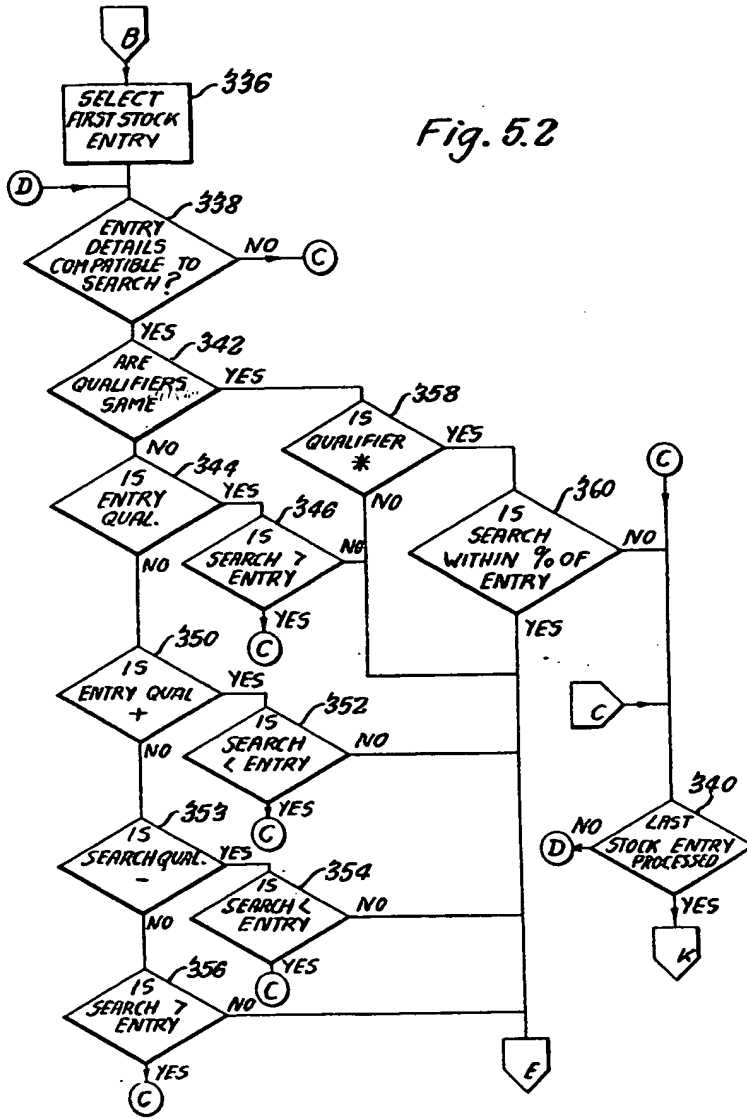

Fig. 5.2



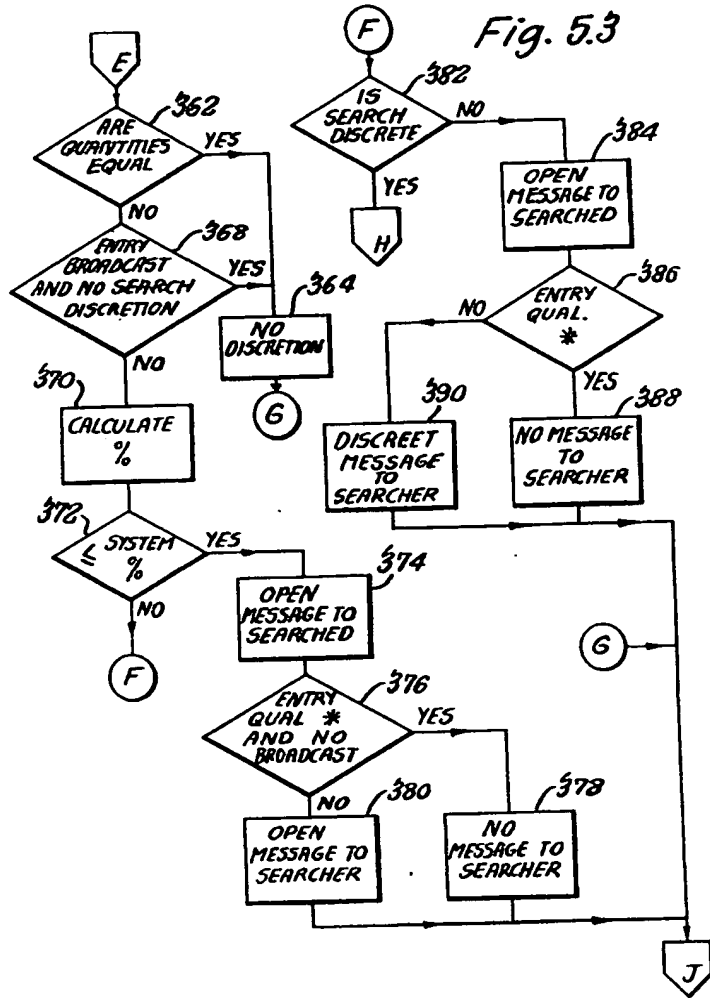

Fig. 5.4

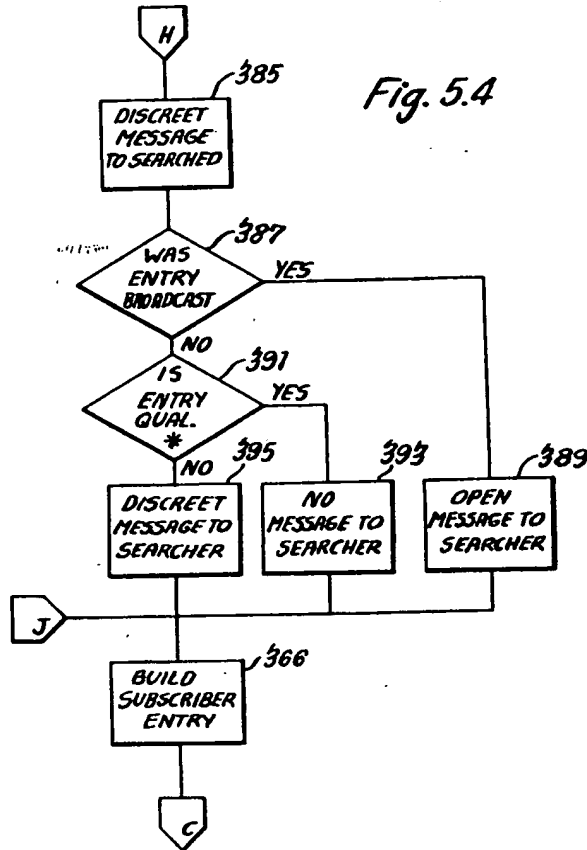



Fig. 5.5

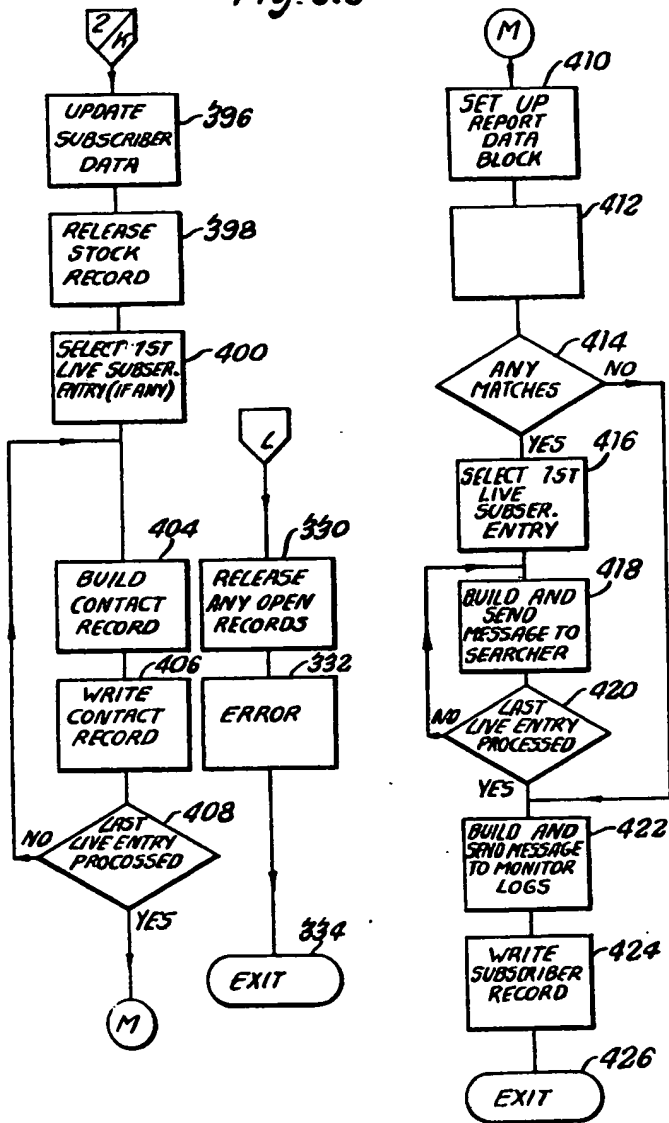

Fig. 6.1

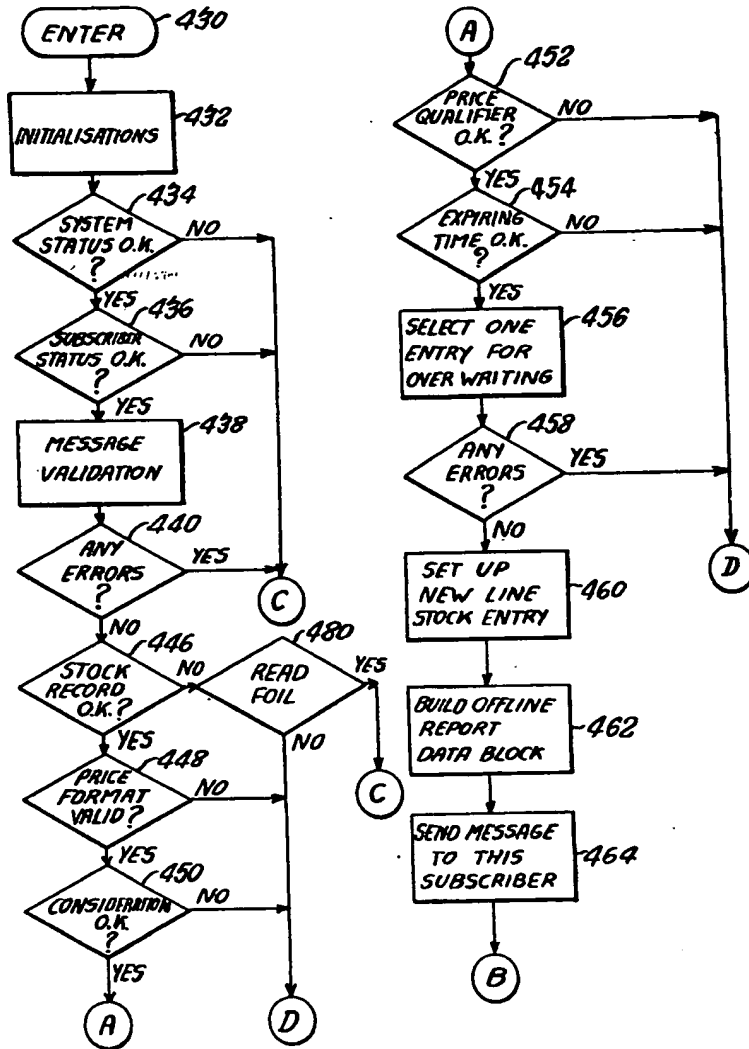

Fig. 6.2

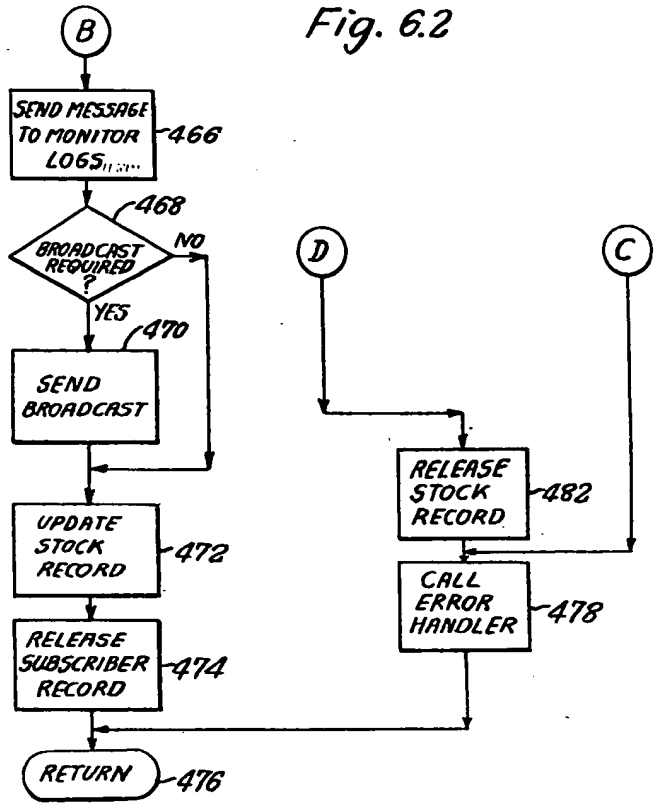

Fig. 7.1

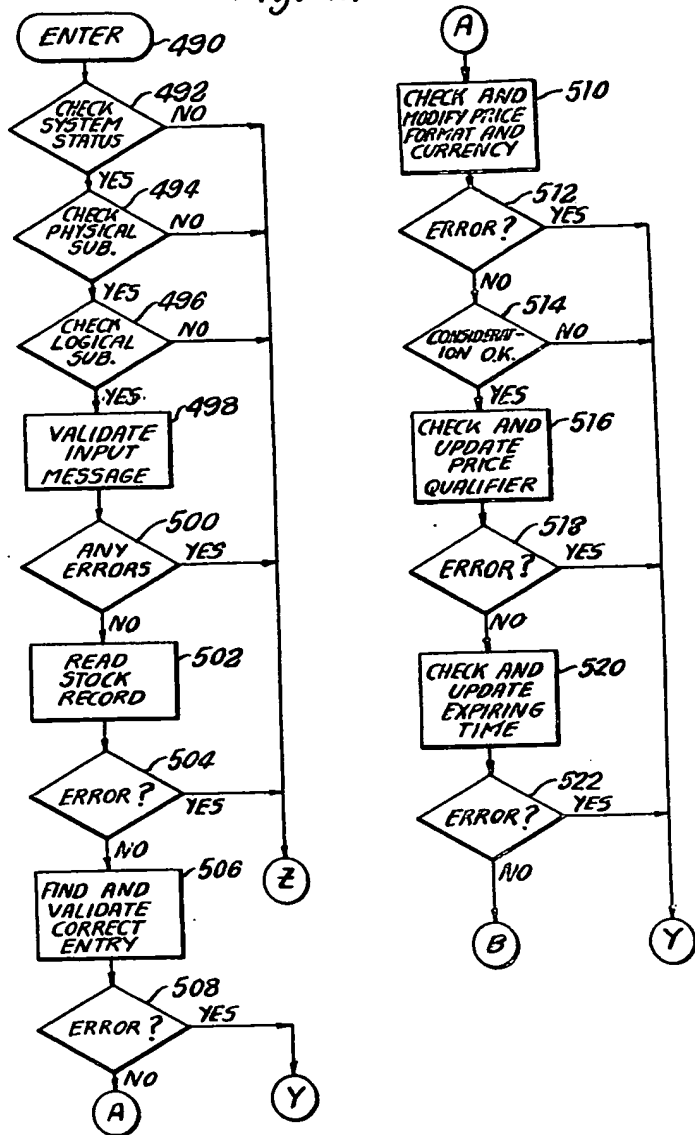
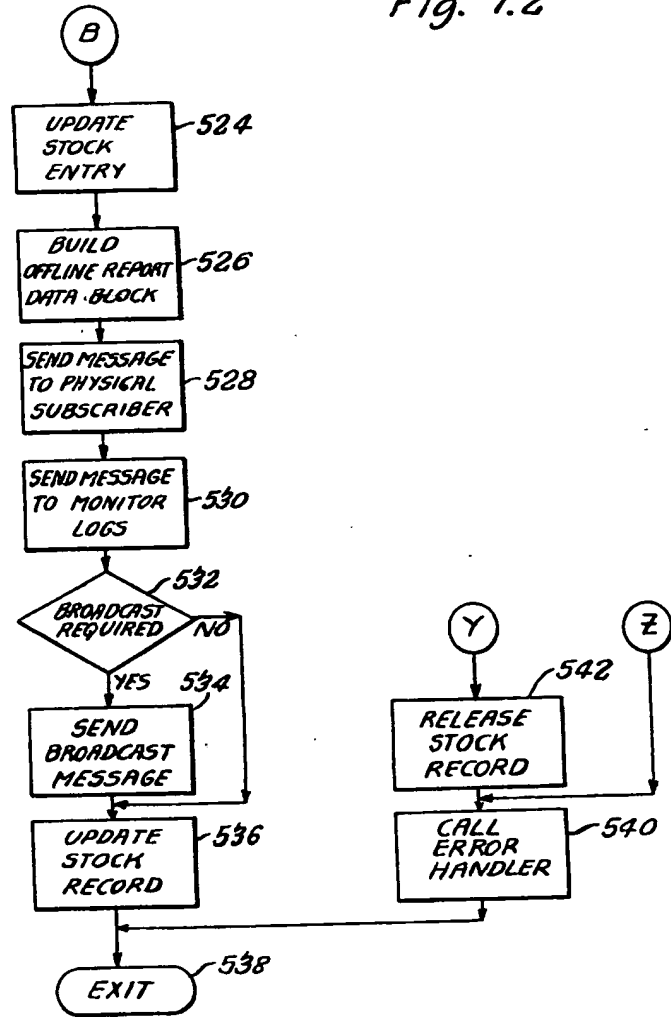

Fig. 7.2



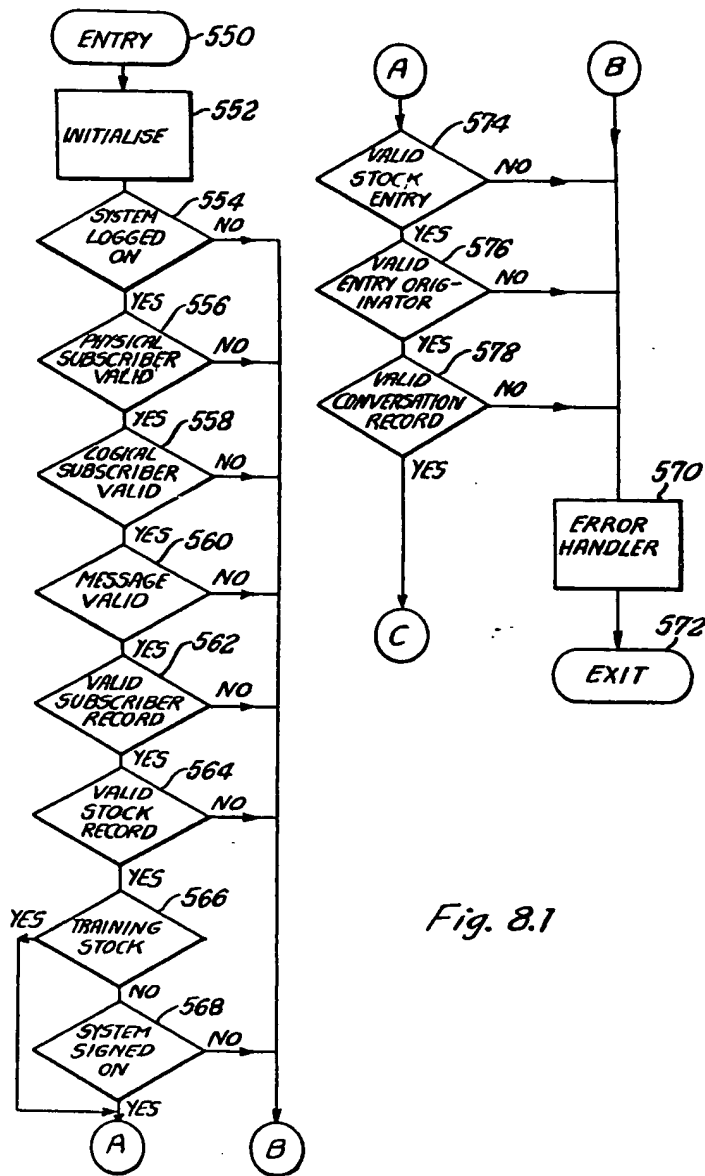

Fig. 8.1

Fig. 8.2

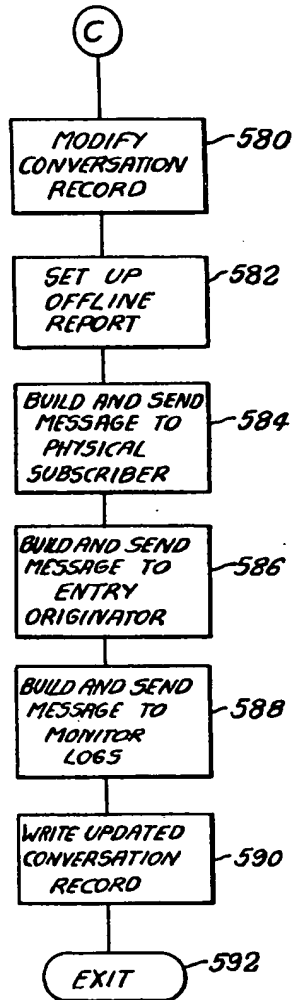

Fig. 9

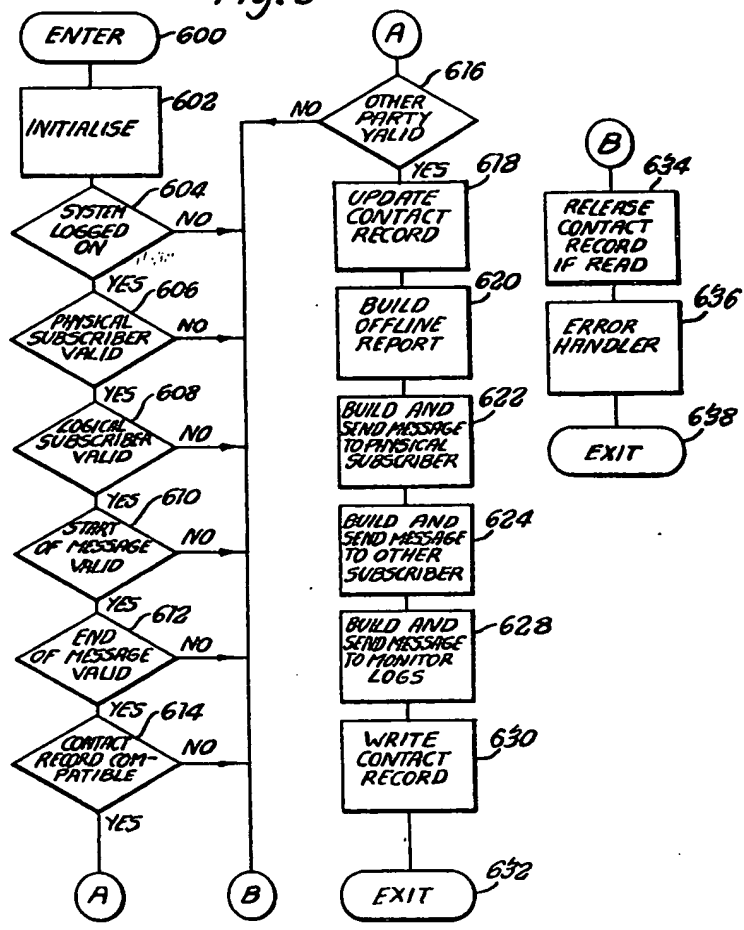



Fig. 10

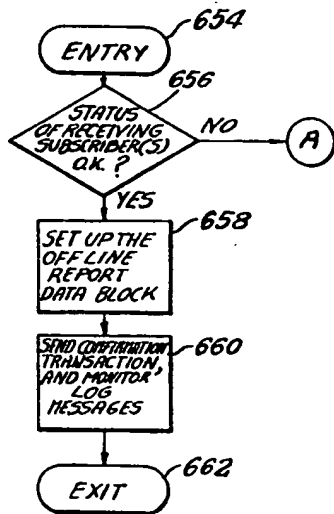
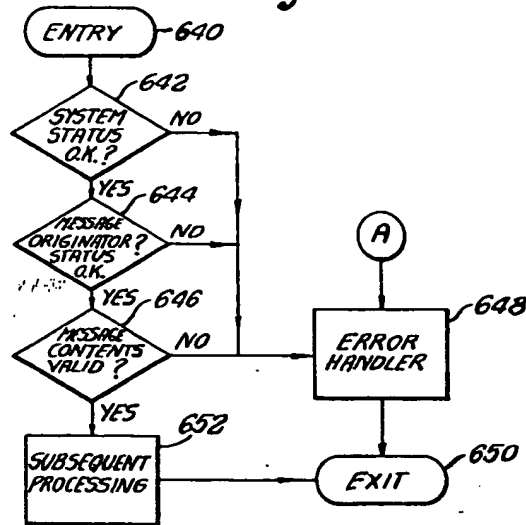

Fig. 11.1

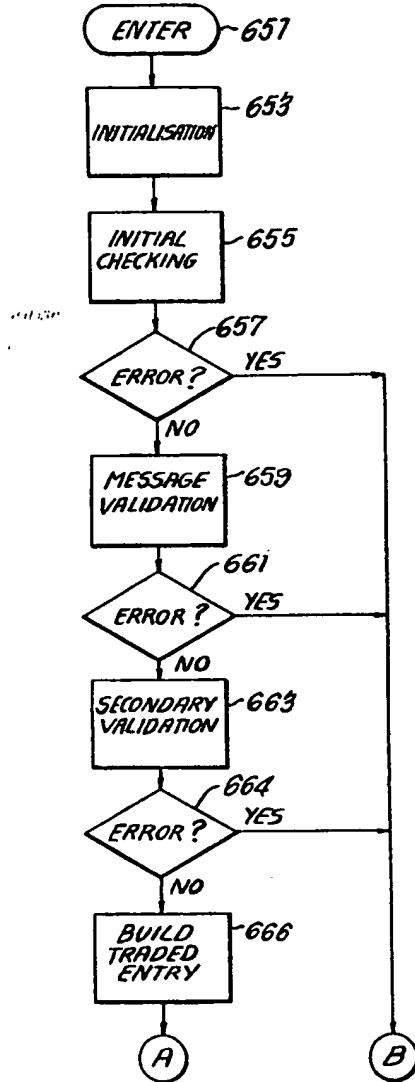

Fig. 11.2

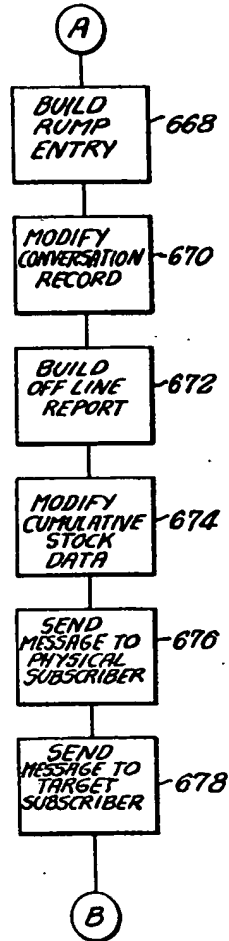
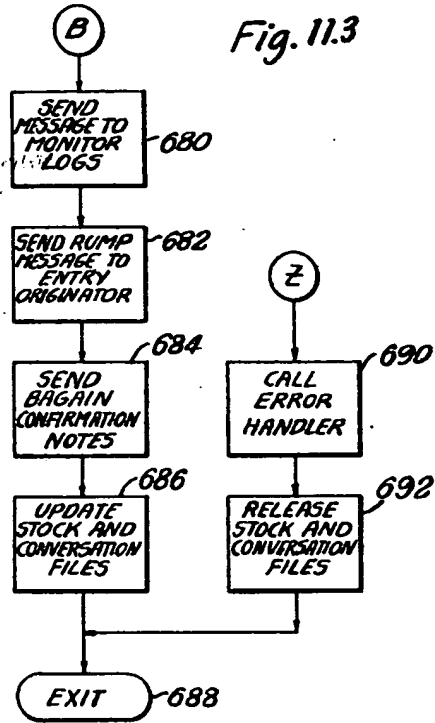

Fig. 11.3



**This Page is Inserted by IFW Indexing and Scanning  
Operations and is not part of the Official Record**

**BEST AVAILABLE IMAGES**

Defective images within this document are accurate representations of the original documents submitted by the applicant.

Defects in the images include but are not limited to the items checked:

- BLACK BORDERS
- IMAGE CUT OFF AT TOP, BOTTOM OR SIDES
- FADED TEXT OR DRAWING
- BLURRED OR ILLEGIBLE TEXT OR DRAWING
- SKEWED/SLANTED IMAGES
- COLOR OR BLACK AND WHITE PHOTOGRAPHS
- GRAY SCALE DOCUMENTS
- LINES OR MARKS ON ORIGINAL DOCUMENT
- REFERENCE(S) OR EXHIBIT(S) SUBMITTED ARE POOR QUALITY
- OTHER: \_\_\_\_\_

**IMAGES ARE BEST AVAILABLE COPY.**

**As rescanning these documents will not correct the image problems checked, please do not report these problems to the IFW Image Problem Mailbox.**